

Millipore
SIGMA

REFINE PROTEIN PREPARATION.

Tools for better protein analysis.

The life science business of Merck KGaA,
Darmstadt, Germany operates as
MilliporeSigma in the U.S. and Canada.

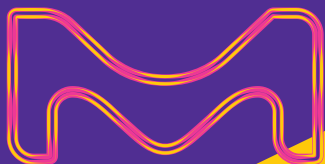

Sigma-Aldrich[®]
Lab & Production Materials

Millipore[®]
Preparation, Separation,
Filtration & Monitoring Products

INTRODUCTION

Today, researchers are challenged to create high quality samples for meaningful protein analysis, often using cumbersome traditional sample preparation methods. With over 50 years of experience in developing protein sample preparation technologies, MilliporeSigma is constantly innovating new tools to offer you rapid and efficient solutions that can be smoothly integrated into your workflow.

Why spend your time on arduous sample preparation protocols when you can focus your efforts on exciting experiments? With the right pure protein, in the buffer you need, at the concentration you want, your next discovery is only a step away. From protein isolation to purification, you can count on us to support your research with maximum yields of intact, functional proteins.

To learn more, please visit: SigmaAldrich.com

KEY FEATURES

Unmatched Flexibility

Isolate proteins from a diverse range of sample types with our flexible, broad range of kits.

Diverse downstream applications

Our reagents enable you to produce samples that can be used directly in applications such as activity assays, protein microarrays, SDS-PAGE, immunoblotting, ELISA, two-dimensional gel electrophoresis (2DGE), mass spectrometry (MS; including MS/MS, LC-MS, MALDI-MS, SELDI-MS, and ESI-MS), and others.

Scale-up compatibility

It's easy to scale up to high-throughput recombinant protein purification and solubility screening using our sample preparation reagents.

Sigma-Aldrich®

MilliporeSigma offers, under the Sigma-Aldrich® brand, a strong and always-expanding portfolio of lab and production materials that keep our customers' important work moving forward. And through our technical support and our scientific partnerships, we help connect our customers to a whole world of progress.

 Denotes Sigma-Aldrich® Products

Millipore®

MilliporeSigma offers, under the Millipore® brand, an ecosystem of industry-leading products and services, spanning preparation, separation, filtration and monitoring — all of which are deeply rooted in quality, reliability and time-tested processes.

 Denotes Millipore® Products

TABLE OF CONTENTS

Protein Extraction	4
Protein Extraction with Cell Lysis Reagents (“Busters”)	5
Fast, simple, gentle protein extraction from <i>E. coli</i> , yeast, insect and mammalian cells	
Cell Lysis and Nucleic Acid Removal Enhancers	7
Increase protein extraction yield and purity with Benzonase® and rLysozyme™ reagents	
Protein Extraction with ProteoExtract® Kits	9
Extract proteins from different fractions of the mammalian cell, including membrane, nucleus, cytosol and cytoskeleton	
Protein Extraction with Inhibitors	11
Protease and phosphatase inhibitor cocktails to prevent proteolysis and dephosphorylation of proteins	
Protein Purification and Depletion	13
Affinity Purification with PureProteome™ Magnetic Beads	14
Ideal for small volume applications such as immunoprecipitation and recombinant protein screening	
Affinity Purification with Recombinant Fusion Tags	17
Protein Depletion	22
Protein depletion reagents: Seppro® Protein Depletion, PureProteome™ reagents, ProteoExtract® depletion, ProteoPrep® products	
Amicon® Pro Purification System	24
Purify, exchange buffer and/or concentrate in a single device	
Protease Cleavage Enzymes.	26
Recombinant enterokinase, factor Xa, HRV 3C protease, thrombin and other enzymes for cleaving fusion proteins	
Protein Buffer Optimization and Sample Concentration	28
Dialysis and Buffer Exchange Devices	29
Amicon® Pro Purification System, D-Tube™ Dialyzers and Amicon® Ultra centrifugal filters for protein sample diafiltration and buffer exchange	
Centrifugal Concentration Devices	32
Amicon® Ultra filters for fast and effective protein concentration	
Specialized Concentration Devices	37
Microcon®, Ultrafree® and Centriprep® filters for efficient purification, concentration, and desalting of biological samples	
Clinical Filtration Devices.	40
Centrifree® and Minicon® concentrators for concentration or partition of body fluids or other biological specimens	
Large Volume Concentration Devices	41
Centricon® Plus-70 centrifugal filters for rapid processing of aqueous biological solutions in larger volumes; stirred cells and cut discs for concentrating volumes up to 400 mL	

PROTEIN EXTRACTION

When purifying proteins for functional or structural studies, the first step is to disrupt the cells or tissue sample and extract the relevant protein fraction. This step is critical because processing methods that require harsh mechanical, chemical, or enzymatic treatments can affect the target protein's integrity and activity, or otherwise expose it to degradative conditions.

Our complete range of reagents and enzymes for cell lysis and protein extraction provide you with an array of options so that you can put together the perfect extraction protocol for your particular cells and protein.

Protein Extraction Reagents Application Guide

Products by Cell Type	Starting Material			Applications			Comments
	Total Culture	Cell Pellet	Tissue	1D PAGE	2D PAGE / IEF	Activity Assay	
<i>E. coli</i>							
BugBuster® Master Mix		■		■	■	■	Combines BugBuster® Protein Extraction Reagent with Benzonase® Nuclease and rLysozyme™ Solution. Convenient, all-in-one protein extraction reagent efficiently lyses bacteria and digests nucleic acids.
BugBuster® Protein Extraction Reagent		■		■	■	■	Efficient protein extraction from <i>E. coli</i> under non-denaturing conditions.
BugBuster® 10X Protein Extraction Reagent		■		■	■	■	A concentrated form of BugBuster® Protein Extraction Reagent. Ideal for extraction when a specific buffer is required for protein stability.
PopCulture® Reagent	■			■		■	Protein extraction from cells directly in the culture medium; no centrifugation required.
Yeast							
YeastBuster™ Protein Extraction Reagent		■		■		■	Efficient protein extraction from yeast under non-denaturing conditions from any volume of culture. Add 0.5 M THP Solution (included) and Benzonase® Nuclease for enhanced efficiency.
Insect							
CytoBuster™ Protein Extraction Reagent		■		■	■*	■	Gentle lysis of insect cells with retention of protein activity for assays and purification. Can use with monolayers or pellets derived from suspension cultures.
Insect PopCulture® Reagent	■			■		■	Lysis of insect cells directly in serum-free medium. Ideal for expression screening of many small samples.
Mammalian							
CytoBuster™ Protein Extraction Reagent		■		■	■*	■	Gentle lysis of mammalian cells with retention of protein activity for assays and purification. Can use with monolayers or pellets derived from suspension cultures.
ProteoExtract® Kits		■		■	■*	■	Extract protein fractions from different parts of the cell. A range of kits offering maximum flexibility.
Stabiliser™ Reagent			■	■	■*	■	Stabilizes functional protein and maintains nucleic acid integrity. Prevents degradation during tissue lysis and storage.
Lysis and Extraction Enhancement							
Gram-negative bacteria (<i>E. coli</i>)							
rLysozyme™ Solution	■	■		■		■	Cleaves bond in peptidoglycan layer of <i>E. coli</i> cell wall.
Lysonase™ Bio-processing Reagent	■	■		■		■	Convenient mixture of rLysozyme™ solution and Benzonase® Nuclease minimizes pipetting steps.
Gram-positive bacteria							
Chicken Egg White Lysozyme Solution	■	■		■		■	Cleaves bond in peptidoglycan layer of bacterial cell wall.
All cells							
Benzonase® Nuclease	■	■		■		■	Degrades all types of nucleic acids for more efficient protein extraction, faster chromatography, and reduced interference in assays.

1D PAGE — One-dimensional Polyacrylamide Gel Electrophoresis

2D PAGE — Two-dimensional Polyacrylamide Gel Electrophoresis

IEF — Isoelectric Focusing

* — Salt must be removed before IEF

Protein Extraction with Cell Lysis Reagents (“Busters”)

Featured Products

Stabiliser™ Reagent

DNA, RNA and protein stabilization in tissue extracts

Maintain nucleic acids and functional proteins with Stabiliser™ reagent, the ONLY reagent that protects the integrity of nucleic acids AND active protein in one uniform lysate mixture. Now, you can stabilize complete, uniform tissue homogenates providing sample-to-sample comparability. The convenient all-in-one Stabiliser™ formulation protects analytes at the time of lysis and provides protection from freeze/thaw cycles during long-term storage for future detection needs:

- Maintain functionally active protein and nucleic acids from the same tissue samples
- Long-term storage and protection from freeze/thaw cycles for future detection needs
- Archive tissue samples if future analyte needs change

A.

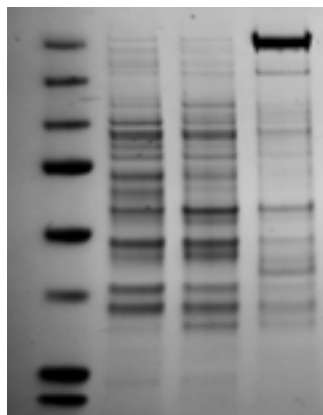

B.

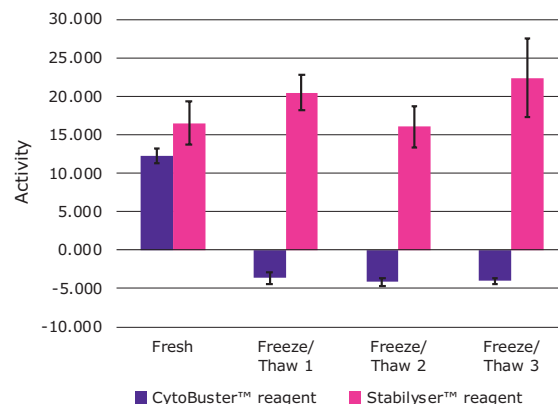

Stabiliser™ reagent extracts higher yields of protein, ~5X more than PBS buffer and 2X more than CytoBuster™ reagent. Additionally, Stabiliser™ reagent protects enzymatic activity during multiple freeze/thaw cycles. (A) 250 mg sections of chicken hearts were lysed in 5 mL CytoBuster™, Stabiliser™ reagents or PBS buffer. Samples were normalized and loaded at 10 µg protein per lane. (B) Enzymatic activity was measured every two days after a freeze/thaw cycle using our IDH activity assay kit on samples stored at -20 °C.

BugBuster® Protein Extraction Kits and Reagents

Simple extraction of soluble protein from *E. coli*, without sonication

Gently disrupt the cell wall of *E. coli* and liberate soluble proteins with BugBuster® Kits and Reagents. BugBuster® reagent provides a simple, rapid, low-cost alternative to mechanical methods such as French press or sonication for releasing expressed target proteins in preparation for purification or other applications. The proprietary formulation uses a detergent mix to perforate cell walls without denaturing soluble protein. Simply harvest cells by centrifugation and suspend in BugBuster® reagent. Following a brief incubation, remove insoluble cell debris by centrifugation. The clarified extract is ready to be purified.

A.

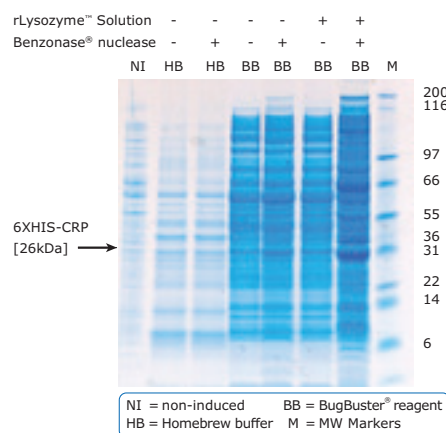

B.

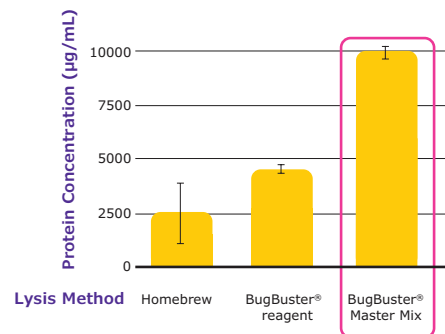

BugBuster® reagent is superior to “homebrew” lysis buffer and BugBuster® reagent with both Benzonase® nuclease and rLysozyme™ solution produced lysates with the highest 6XHIS-CRP yields. (A) *E. coli* lysates (5 µL of 1 mL total lysate) from various lysis protocols were fractionated and analyzed by SDS-PAGE. A band corresponding to 6XHIS-CRP is prominently visualized in the BB +/+ lane. (B) Cleared cell lysates (2 µL of 1 mL total) were spotted on assay cards and quantified using the Direct Detect® spectrometer. In each case, bars represent the average of 3 independent samples.

How do I choose between BugBuster® Products?

Components of Bacterial Lysis Reagents

	BugBuster® Reagent	Buffer	Benzonase® Nuclease	rLysozyme™ Solution	Notes
BugBuster® Reagent	■	■			
BugBuster® 10X reagent	■				Flexibility to customize dilution and buffer composition
BugBuster® Plus Benzonase® Nuclease	■	■	■		2 separate vials for greater flexibility
BugBuster® Plus Lysonase™ Kit	■	■	■	■	2 separate vials for greater flexibility
BugBuster® Master Mix	■	■	■	■	1 convenient reagent
PopCulture® Reagent	■	■			Buffer protects protein from the pH extremes produced in high-density culture media, enabling extraction directly in medium.

We offer a family of protein extraction reagents for gentle, efficient, non-mechanical extraction of soluble proteins from bacteria, yeast, plant, mammalian, and insect cells. ●

CytoBuster™ reagent — Obtain protein extracts from mammalian and insect cells in their native state, in 5 minutes.

NucBuster™ reagent — Extract nuclear proteins in less than 30 minutes with a simple 2-step protocol.

PhosphoSafe™ Extraction reagent — The PhosphoSafe™ Extraction Buffer is a detergent and phosphatase inhibitor mixture optimized for fast, efficient extraction of soluble proteins from mammalian and insect cells that preserves the phosphorylation state of sample proteins.

YeastBuster™ reagent — Extract proteins from yeast and plants without mechanical disruption or enzymatic lysis. The reagent has been tested with

Saccharomyces cerevisiae, *Pichia pastoris*, *P. stipidis*, and *Schizosaccharomyces pombe* strains, and with plant cells.

Insect PopCulture® reagent — Insect PopCulture® Reagent is a detergent-based lysis reagent specifically formulated for extraction from total insect cell culture (in suspension or adherent) without the need for centrifugation.

Stabilyser™ reagent — Use Stabilyser™ reagent and protect both nucleic acids and functional proteins in one uniform lysate mixture. Stabilyser™ reagent provides long-term storage and protection from freeze/thaw cycles.

Ordering Information

Application	Description	Catalog No.
Bacteria	BugBuster® Protein Extraction Reagent	70584
	BugBuster® Master Mix	71456
	BugBuster® Plus Benzonase® Nuclease	70750
	BugBuster® Plus Lysonase™ Kit	71370
	BugBuster® 10X Protein Extraction Reagent	70921
	PopCulture® Reagent	71092
Mammalian	CytoBuster™ Protein Extraction Reagent	71009
	NucBuster™ Protein Extraction Reagent	71183
	PhosphoSafe™ Extraction Reagent	71296
	Stabilyser™ Reagent	PNS1010
Yeast	YeastBuster™ Protein Extraction Reagent	71186
Insect	Insect PopCulture® Reagent	71187

CellLytic™ Lysis Reagents ▶

Features and Benefits

- **Efficient:** Higher protein extraction efficiency than traditional methods such as sonication and lysozyme
- **Non-denaturing:** Does not interfere in downstream applications including immunoprecipitation, kinase and phosphatase assays, reporter gene assays and gel shift assays
- **Convenient, ready-to-use reagent**

CellLytic™ reagents are specifically formulated to lyse and extract cellular proteins based on the type of expression system. All are designed to rapidly lyse the

cells with an easy-to-follow protocol. The CellLytic™ family is compatible with a wide variety of protease inhibitors, chelating agents, and chaotropes. Because the proteins are in a non-denaturing environment, these reagents do not interfere with standard affinity chromatography. Downstream applications, such as Western blots, gel-shift assays, affinity purification, and reporter detection can be performed without removing the CellLytic™ reagent. Overall extraction efficiency is consistently higher than with other common protocols, such as freeze-thaw or sonications. Although each CellLytic™ reagent is uniquely formulated, all are amenable to scale-up to meet any laboratory's needs.

Ordering Information

Application	Description	Catalog No.
Bacteria	CellLytic™ B Cell Lysis Reagent, 10X Concentrate	C8740
	CellLytic™ B Cell Lysis Reagent, 2X Concentrate	B7310
	CellLytic™ B Cell Lysis Reagent, Standard Strength	B7435
	CellLytic™ B Plus Kit	CB0050, CB0500
	CellLytic™ Express reagent, for in-culture bacterial cell lysis	C1990
	CellLytic™ Express reagent, 1 mL tablets, for direct lysis of bacterial cultures and for use in the His-Select® iLAP column	C5236
Mammalian	CellLytic™ M, Cell Lysis Reagent	C2978
	CellLytic™ Mem Protein Extraction Kit, for membrane proteins	CE0050
	CellLytic™ MT Cell Lysis Reagent, for mammalian tissues	C3228
	CellLytic™ Nuclear™ Extraction Kit, for mammalian tissue or cultured cells	NXTRACT
Plant	CellLytic™ P Cell Lysis Reagent	C2360
	CellLytic™ PN Isolation/Extraction Kit, for plant leaves	CELLYTPN1
Yeast	CellLytic™ Y Cell Lysis Reagent	C4482
	CellLytic™ Y Plus Kit for enzymatic yeast cell lysis	CYP1

Cell Lysis and Nucleic Acid Removal Enhancers

Featured Products

Benzonase® Nuclease ●

Effectively reduce viscosity and remove nucleic acids from protein solutions

Benzonase® Nuclease is a genetically engineered endonuclease from *Serratia marcescens*. It degrades all forms of DNA and RNA (single stranded, double stranded, linear and circular) while having no proteolytic activity. It is effective over a wide range of conditions and has an exceptionally high specific activity. Benzonase® nuclease is an excellent choice for viscosity reduction to shorten processing time and increase protein yields.

Benzonase® Advantages

- Compliant with FDA guidelines for nucleic acid contamination
- Functional between pH 6 and 10, from 0 °C to 42 °C, for maximum versatility
- Active in the presence of ionic and non-ionic detergents, reducing agents, PMSF (1 mM), EDTA (1 mM) and urea.
- Available in ultrapure (> 99% by SDS-PAGE) and pure (> 90%) grades
- Available in standard concentration (25 U/μL) and high concentration (HC, 250 U/μL).

Nucleic acid digestion by Benzonase® Nuclease.
E. coli BL21(DE3) cells containing a pET construct were suspended in BugBuster® Reagent (5 mL/g wet weight). Identical volumes of the suspension were treated with the indicated amounts of Benzonase® Nuclease for 30 min at room temperature. Samples were clarified by centrifugation and analyzed by agarose gel electrophoresis and ethidium bromide staining.

***E. coli* lysate without Benzonase® Nuclease.**
 Gooney, viscous, difficult to handle.

rLysozyme™ Solution

Degrade bacterial cell walls with stabilized recombinant lysozyme

rLysozyme™ Solution contains a highly purified and stabilized recombinant lysozyme that can be used for lysis of *E. coli*. The enzyme catalyzes the hydrolysis of N-acetylmuramide linkages in bacterial cell walls. The specific activity of rLysozyme™ solution (1700 KU/mg) for *E. coli* lysis is 250 times greater than that of traditional chicken egg white lysozyme. rLysozyme™ solution is optimally active at physiological pH. Very small amounts of rLysozyme™ solution enhance the efficiency of protein extraction with BugBuster® and PopCulture® Reagents. The product is supplied as a ready-to-use solution and is stable at -20 °C.

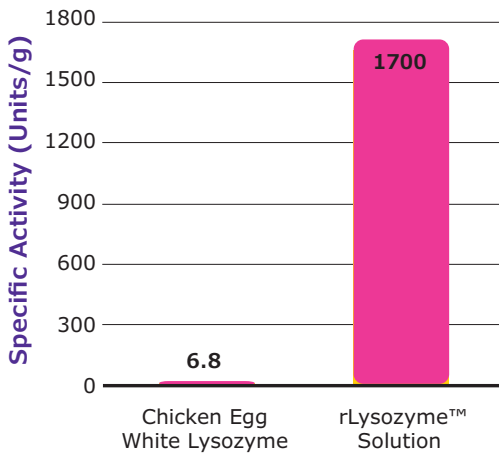
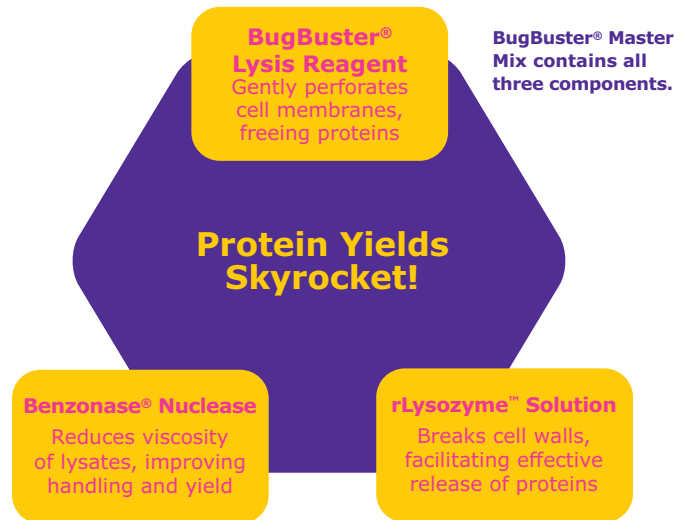

rLysozyme™ solution exhibits 250 times higher specific activity than chicken egg white activity when measured using a standard activity assay.

Ordering Information

Description	Catalog No.
Benzonase® Nuclease, Purity > 90%	70746
Benzonase® Nuclease HC, Purity > 90%	71205
Benzonase® Nuclease, Purity > 99%	70664
Benzonase® Nuclease HC, Purity > 99%	71206
rLysozyme™ Solution	71110
Chicken Egg White Lysozyme Solution	71412
Lysonase™ Bioprocessing Reagent	71230

Protein Extraction with ProteoExtract® Kits

Featured Products

ProteoExtract® Subcellular Proteome Extraction Kit (S-PEK) ●

Reproducible extraction of subcellular proteomes from mammalian cells.

Based on different solubilities of certain subcellular compartments, the S-PEK uses proprietary chemistries to yield four subproteome fractions which are enriched in cytosolic, membrane/organelle, nuclear, and cytoskeletal proteins. In the case of adherent cells, the procedure is performed directly in the tissue culture dish without the need for cell removal. For suspension-grown cells, extraction starts with gentle sedimentation and washing of cells. Extraction from tissues requires isolation of viable cells before proceeding with the extraction protocol.

Applications of S-PEK:

- Subcellular redistribution assays to monitor protein translocation
- Enzyme activity assays including reporter gene assays and kinase assays
- SELDI (surface-enhanced laser desorption/ionization) profiling
- Non-denaturing gel electrophoresis
- Assaying protein expression levels using fluorescently-labeled subcellular extracts in microarrays

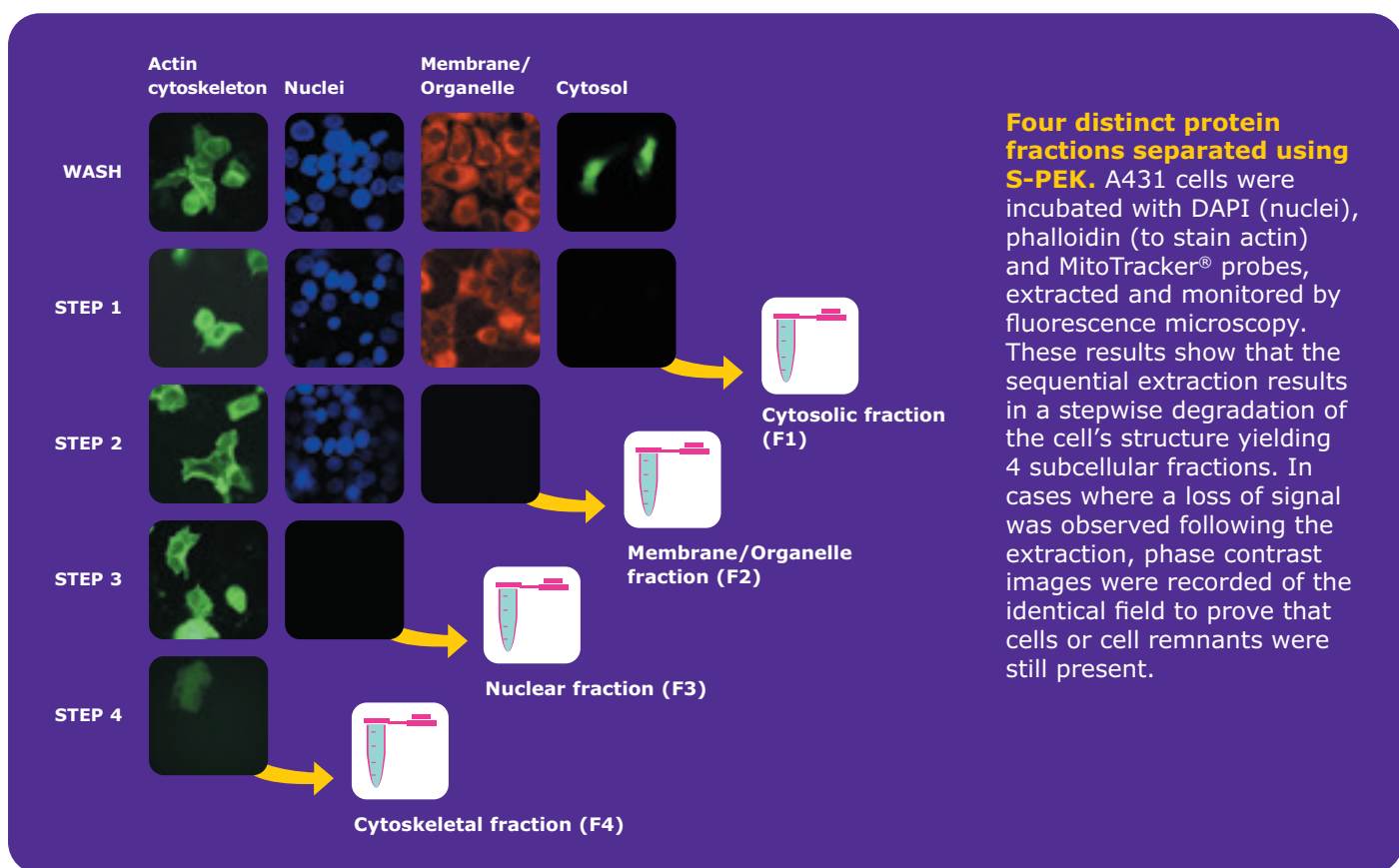

ProteoExtract® Native Membrane Protein Extraction Kit (M-PEK)

Isolation of native membrane proteins from mammalian cells and tissue.

Extract proteins associated with cellular membranes with M-PEK. Extremely mild extraction conditions yield a 3–5 fold enrichment of integral membrane and membrane-associated proteins. The simple, two-step procedure enables processing of multiple samples in parallel. Extraction from tissues requires isolation of viable cells before proceeding with the extraction protocol.

Applications for Extracted Membrane Proteins:

- Enzyme activity assays, including reporter gene assays and kinase assays
- Non-denaturing and denaturing gel electrophoresis, immunoblots and immunoassays
- Assaying post-translational modifications, such as phosphorylation
- SELDI-profiling of integral and membrane-associated proteins
- NHS ester labeling of membrane proteins

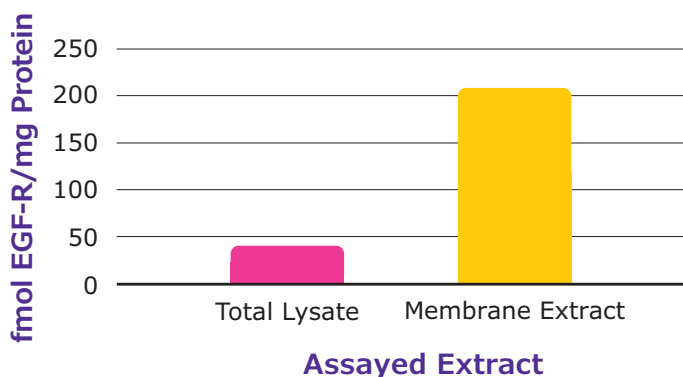

Notably increased enrichment of EGF receptor using M-PEK compared to total cell lysate. HEK293 cells were extracted with buffered 1% Triton® X-100 surfactant to generate a total lysate or extracted with M-PEK to yield a membrane fraction. Equal volumes of these fractions were utilized to quantitate the concentration of EGF receptor in the samples using an EGF-R ELISA Kit. Protein concentrations were used to calculate the amount of EGF-R per mg protein in the total lysate and the membrane fraction. The measurements demonstrate a 4.5 fold enrichment of the EGF receptor in the M-PEK-extracted membrane fraction.

Ordering Information

Application	Description	Catalog No.
Organelle Fractionation	ProteoExtract® Subcellular Protein Extraction Kit	539790
	ProteoExtract® Complete Mammalian Protein Extraction Kit	539779
	ProteoExtract® Cytosol/Mitochondria Fractionation Kit	QIA88
	ProteoExtract® Native Cytoskeleton Enrichment Kit	17-10210
	ProteoExtract® Cytoskeleton Enrichment and Isolation Kit	17-10195
Membrane Proteins	ProteoExtract® Native Membrane Protein Extraction Kit	444810
	ProteoExtract® Transmembrane Protein Extraction Kit	71772
Mass Spec Peptide Enrichment	ProteoExtract® All-in-One Trypsin Digestion Kit	650212
	ProteoExtract® Glycopeptide Enrichment Kit	72103
	ProteoExtract® Phosphopeptide Enrichment TiO ₂ Kit	539722

ProteoPrep® Lysis Kits

ProteoPrep® kits and individual extraction reagents allow for selective or total protein extracts from cellular samples. The protein extractions obtained with each component can be optimized to meet your individual needs. The reducing and alkylating reagents produce protein samples that exhibit improved focusing and decreased streaking in 2D gels. Enough of each component is provided to process multiple protein samples. For researchers who have optimized an extraction protocol using one chaotropic extraction reagent, each kit reagent is also available as an individual product.

Features and Benefits:

- **Innovative detergent preparations** — Improved solubility allows for higher protein loads and greater visibility of low abundance proteins in 2D gels.
- Pre-mixed solubilization solutions

Ordering Information

Description	Catalog No.
ProteoPrep® Total Extraction Sample Kit	PROTTOT
ProteoPrep® Universal Extraction Kit	PROTTWO
ProteoPrep® Membrane Extraction Kit	PROTMEM
ProteoPrep® Detergent Sample Kit	PROTDT
ProteoPrep® Reduction and Alkylation Kit	PROTRA

Protein Extraction with Inhibitors

Featured Products

Protease Inhibitor Cocktails ▶

Prevent protein degradation by proteases during extraction and purification

Ensure the integrity of purified proteins by using protease inhibitor cocktails and highly specific protease inhibitors. During protein expression and isolation, endogenous proteases rapidly begin to degrade protein samples, reducing the quality and quantity of protein samples required for characterization and analysis. By using the right combination of protease inhibitors, you can protect your purified protein preparations from common proteases including serine proteases, metalloproteases, cysteine proteases, aminopeptidases, and aspartic proteases.

Ordering Information

Application	Description	Catalog No.
SIGMAFAST™ Tablets	SIGMAFAST™ Protease Inhibitor Tablets, For General Use	S8820
	SIGMAFAST™ Protease Inhibitor Cocktail Tablets, EDTA-Free, for use in purification of Histidine-tagged proteins	S8830
For General Use	Protease Inhibitor Cocktail, for general use, lyophilized powder	P2714
For Bacterial Extracts	Protease Inhibitor Cocktail, for use with bacterial cell extracts, lyophilized powder	P8465
For Mammalian Cell & Tissue Extracts	Protease Inhibitor Cocktail, for use with mammalian cell and tissue extracts, DMSO solution	P8340
For HIS-Tagged Proteins	Protease Inhibitor Cocktail, for use in purification of Histidine-tagged proteins, DMSO solution	P8849
For Tissue Culture	Protease Inhibitor Cocktail, for use in tissue culture media, DMSO solution	P1860
For Plant Extracts	Protease Inhibitor Cocktail, for plant cell and tissue extracts, DMSO solution	P9599
For Fungal & Yeast Extracts	Protease Inhibitor Cocktail, for use with fungal and yeast extracts, DMSO solution	P8215

Roche cComplete™ Inhibitors

Roche offers a broad selection of protease inhibitors, as well as optimized lysis reagents, to ensure maximum yields of intact and functional proteins.

Don't spend valuable time and money repeating experiments in order to obtain sufficient yields of intact, functional proteins. Insist on Roche's high-quality protease inhibitors and lysis reagents to maximize success when isolating and purifying proteins.

Convenience

- Inhibit proteolytic activity in extracts from almost any tissue or cell type, including animals, plants, yeast, bacteria, and fungi.
- Drop a quick-dissolving tablet into your lysis buffer and eliminate the cumbersome job of weighing small amounts of different protease inhibitors on an analytical scale and dissolving the mix in DMSO.

Reliability

- Obtain stable, non-toxic protection in aqueous buffers.
- Consistently inhibit a multitude of protease classes, including serine proteases, cysteine proteases, and metalloproteases.

Enjoy Complete Protection

With eight powerful inhibitors, cComplete™ ULTRA Tablets reliably protect against a broad range of proteases for your most vital protein applications. For routine protein analyses, rely on the proven performance and convenience of classic cComplete™ Tablets from Roche. If your research requires inhibition of both proteases and phosphatases, combine cComplete™ ULTRA or cComplete™ Tablets with PhosSTOP™ Tablets for comprehensive protection.

Ordering Information

Description	Qty	Catalog No.
cComplete™ Tablets	20 tablets	11697498001
	3 x 20 tablets	11836145001
cComplete™ Tablets, EASYpack	20 tablets	4693116001
cComplete™ Tablets, EDTA-free	20 tablets	11873580001
	3 x 20 tablets	5056489001
cComplete™ Tablets, EDTA-free, EASYpack	20 tablets	4693132001
cComplete™ Tablets ULTRA, EDTA-free	2 x 10 tablets	5892953001
	6 x 10 tablets	6538282001
cComplete™ Tablets ULTRA	2 x 10 tablets	5892988001
	6 x 10 tablets	6538304001
cComplete™ Tablets, Mini	25 tablets	11836153001
cComplete™ Tablets, Mini, EASYpack	30 tablets	4693124001
cComplete™ Tablets, Mini, EDTA-free	25 tablets	11836170001
cComplete™ Tablets, Mini, EDTA-free, EASYpack	30 tablets	4693159001
cComplete™ Tablets ULTRA, mini, EASYpack	30 tablets	5892970001
cComplete™ Tablets ULTRA, mini, EDTA-free, EASYpack	30 tablets	5892791001

Choose easy-to-use, versatile cComplete™ Protease Inhibitor Cocktail Tablets to obtain the protection you need, with convenience and reliability. Try cComplete™ Tablets today, and see how simple success can be.

cComplete™ ULTRA or cComplete™ Tablets selection guide

	Performance				Convenience	
	Serine Proteases	Cysteine Proteases	Aspartic Proteases	Metalloproteases	Stability stock solution	Concentration stock solution*
cComplete™ ULTRA Tablets, EDTA-free	+++	++	+		++	2x
cComplete™ ULTRA Tablets	+++	++	+	+	++	2x
cComplete™ Tablets, EDTA-free	++	+			+++	25x
cComplete™ Tablets	++	+		+	+++	25x

Phosphatase Inhibitor Cocktails

Prevent protein dephosphorylation for cell signaling studies

It is critical to preserve the phosphorylation state of proteins of interest during their extraction from cell and tissue lysates. To effect cell signaling, target proteins are phosphorylated by protein kinases that transfer a phosphate group to specific sites, typically at serine, threonine, or tyrosine residues. These phosphate groups can be removed by endogenous protein phosphatases,

restoring the protein to its original dephosphorylated state. Using phosphatase inhibitors can reveal the signaling status inside a cell at a specified timepoint. We offer a variety of Phosphatase Inhibitor cocktails and a PhosphoSafe™ Extraction Reagent that help protect phosphoproteins from different families of phosphatases.

Roche PhosSTOP™ Phosphatase Inhibitor Tablets

Achieve immediate, effective, and convenient inhibition of a broad spectrum of phosphatases across a wide range of sample materials (mammalian, plant, yeast, and bacteria) with non-toxic PhosSTOP™ Phosphatase

Inhibitor Cocktail Tablets. Cited in thousands of peer-reviewed papers, PhosSTOP™ Tablet is a proprietary blend of phosphatase inhibitors, formulated as a ready-to-use, quick-dissolving, water-soluble tablet.

Ordering Information

Description	Recommended Application	Catalog No.
Phosphatase Inhibitor Cocktail Set I	Protection against alkaline phosphatases and Ser/Thr phosphatases such as PP1 and PP2A	524624
Phosphatase Inhibitor Cocktail Set II	Protection against acid and alkaline phosphatases and Protein Tyrosine Phosphatases (PTPs)	524625
Phosphatase Inhibitor Cocktail Set III	Protection against acid, alkaline and Ser/Thr phosphatases and Protein Tyrosine Phosphatases (PTPs)	524627
Phosphatase Inhibitor Cocktail Set IV	Protection against alkaline phosphatases and Ser/Thr phosphatases such as PP1 and PP2A	524628
PhosSTOP™ Phosphatase Inhibitor Tablets	Broad-spectrum blend of mammalian, plant, yeast, and bacterial phosphatase inhibitors	4906845001

PROTEIN PURIFICATION AND DEPLETION

Affinity purification is based on the specific interaction of a target molecule with an immobilized ligand. We offer a wide range of tools for protein purification, including affinity magnetic beads, affinity agarose resins, the Amicon® Pro purification system and protease cleavage enzymes. To ensure that samples are enriched for protein(s) of interest, our depletion reagents eliminate common irrelevant, abundant proteins that may confound protein analysis. ●



- PureProteome™ magnetic beads are ideal for small volume affinity purification assays, such as immunoprecipitation and serum depletion or enrichment.
- Affinity agarose portfolio for larger volume applications, such as antibody purification and recombinant protein purification.
- Amicon® Pro purification system is ideal for small volume affinity purification assays followed by buffer exchange and/or concentration.
- Protease cleavage enzymes available in restriction grade or in kits for cleaving fusion proteins.



Affinity Purification with PureProteome™ Magnetic Beads ●

PureProteome™ Protein A and G Beads: Fast and easy immunoprecipitation

Traditional methods require hours of incubation time and harsh centrifugation to isolate sample. In contrast, PureProteome™ magnetic beads enhance binding equilibrium, enabling faster, gentler processing. The beads are easily resuspended for fast mixing and efficient interaction between the beads and protein.

PureProteome™ Protein A/G Mix Beads

Bind all mammalian immunoglobulin G (IgGs) efficiently using PureProteome™ Protein A/G mix magnetic beads, which provide a 50:50 blend of Protein A and Protein G.

Advantages of PureProteome™ Immunoprecipitation:

- **Be efficient with high capacity beads:** increased surface area allows for significantly greater binding capacity than other beads
- **Achieve high purity:** low non-specific binding of irrelevant proteins
- **Save time with fast sample processing:** enhanced binding equilibrium decreases incubation times by > 50%

PureProteome™ NHS and Carboxy FlexiBind beads

Customize your beads quickly and easily

Tailor your beads to match your application. Studying protein-protein interactions? Immobilizing enzymes, nucleic acids or small molecules? PureProteome™ NHS and Carboxy FlexiBind magnetic beads offer you flexibility in binding your target ligand. Customization of beads requires only that the target ligand has a free amine group.

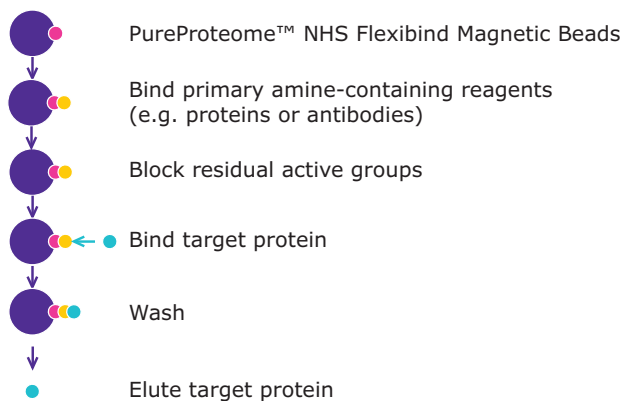

PureProteome™ NHS FlexiBind Magnetic Beads (perfect for the first time user)

- **Fast:** Customize your own beads in < 60 min
- **Easy to Use:** Kit contains everything you need: beads, all buffers and Amicon® Ultra centrifugal filters for eliminating unreacted species
- **Robust:** Little experience or optimization required

PureProteome™ Carboxy FlexiBind Magnetic Beads (for the experienced user)

- **Flexible:** Choice of 0.3 µm, 1 µm or 2.5 µm COOH magnetic beads
- **Automation-Compatible:** Smaller beads have higher buoyancy properties while retaining strong magnetic capability

- **Flexibility:** Choose from a range of sizes and chemistries to fit your application
- **Cost Savings:** Less sample and reagent waste

PureProteome™ Beads

High speed immunoprecipitation with magnetic beads compared to agarose. In parallel indirect immunoprecipitations, PureProteome™ magnetic beads offered a 50% reduction in incubation time while yielding results equivalent to agarose beads.

Excellent yields.
Exceptional purity.
Faster protocol.

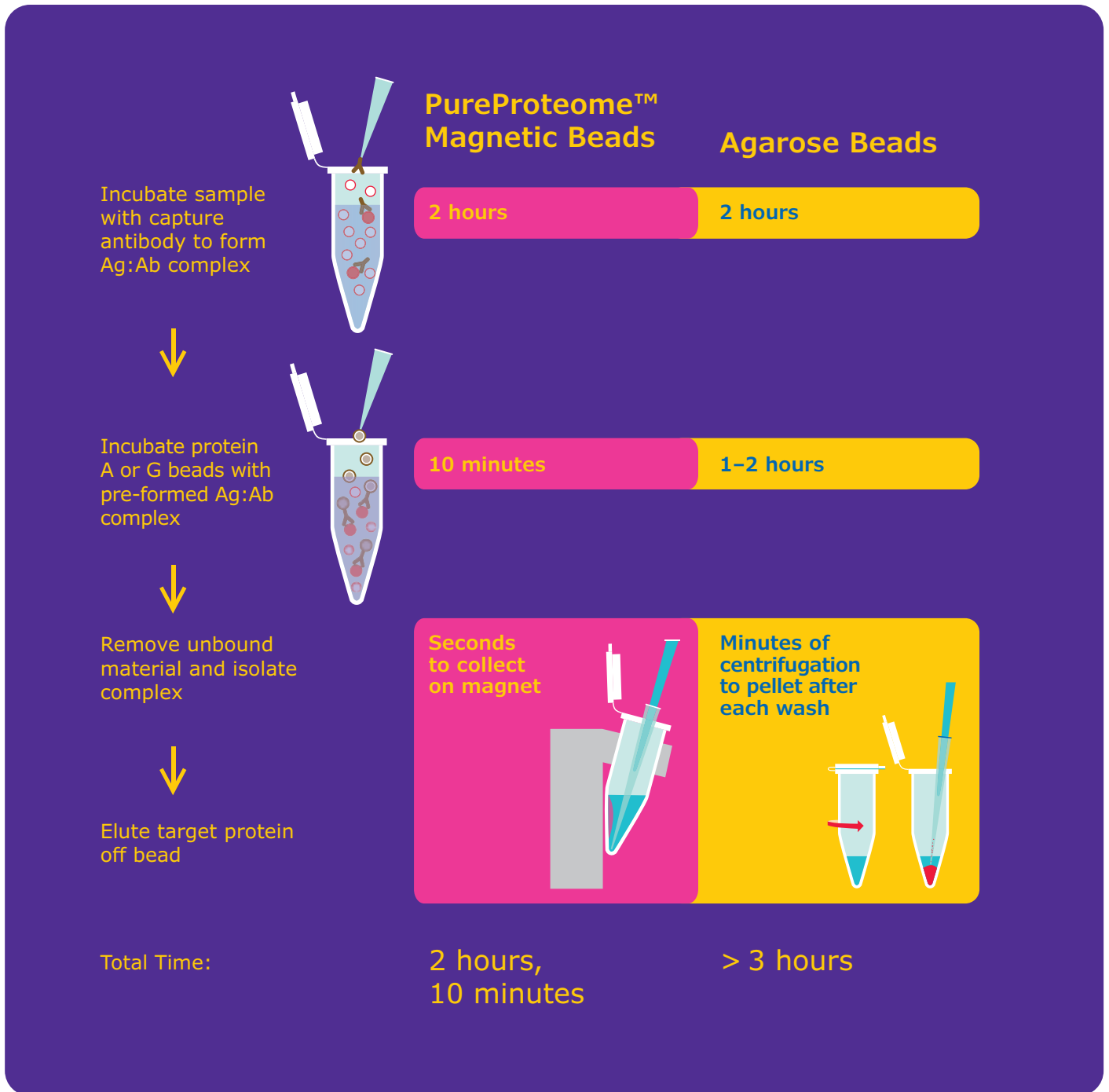

PureProteome™ Kappa and Lambda Ig Binder Beads

Immunoprecipitate all Human Antibodies (including IgA, IgD, IgE and IgM)

PureProteome™ Kappa Magnetic Beads bind to the kappa light chain constant region on human immunoglobulins with high specificity, and Lambda Magnetic Beads bind to the lambda light chain constant region. These novel magnetic beads are capable of capturing all immunoglobulin subtypes (IgG, IgA, IgD, IgE, and IgM) and provide a rapid, scalable, and reproducible means

to capture human antibody or antibody fragments containing kappa or lambda light chains — including F(ab) and F(ab')₂.

Depletion of all human immunoglobulins can be performed by mixing PureProteome™ Kappa and Lambda Magnetic Beads.

Relative Affinity

	Protein A/G Mix	Protein A	Protein G	Kappa Ig Binder	Lambda Ig Binder	Kappa/Lambda Mix*
Antibodies						
Rabbit IgG	●	●	●			
Mouse IgM	●	●				
Mouse IgG ₃	●	●	●			
Mouse IgG _{2b}	●	●	●			
Mouse IgG _{2a}	●	●	●			
Mouse IgG ₁	●	●	●			
Human IgM	●	●		●	●	●
Human IgE	●	●		●	●	●
Human IgD	●	●		●	●	●
Human IgA	●	●		●	●	●
Human IgG ₄	●	●	●	●	●	●
Human IgG ₃	●		●	●	●	●
Human IgG ₂	●	●	●	●	●	●
Human IgG ₁	●	●	●	●	●	●
Rat IgM	●	●				
Rat IgG _{2c}	●	●	●			
Rat IgG _{2b}	●	●	●			
Rat IgG _{2a}	●	●	●			
Rat IgG ₁	●	●	●			
Rat IgG	●	●	●			

* PureProteome™ Kappa/Lambda mix is not a catalog item. Simply procure the Kappa and Lambda beads individually and mix at a 1:1 ratio.

	A/G Mix	Protein A	Protein G	Kappa Ig Binder	Lambda Ig Binder	Kappa/Lambda Mix*
Fragments						
Human I					●	●
Human k				●		●
Human Fc	●	●	●			
Human scFv	●	●		●	●	●
Human F(ab') ₂	●	●	●	●	●	●
Human F(ab)	●	●	●	●	●	●

Key code for relative affinity of protein A and G; PureProteome™ Kappa and Lambda magnetic beads for respective antibodies:

- Strong Affinity
- Moderate/Slight Affinity
- Requires Evaluation

PureProteome™ Kappa or Lambda light chain ligands bind to the constant region of the antibody light chain, and will not bind the scFv.

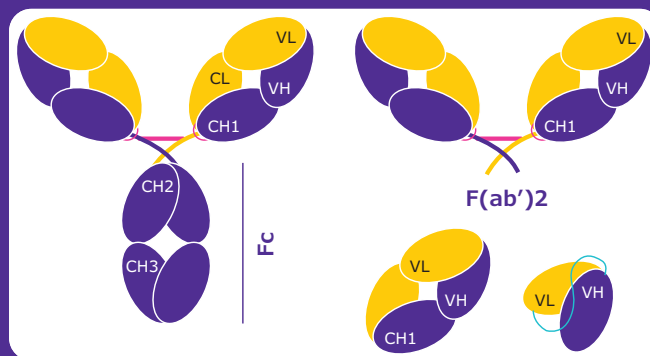

Ordering Information

Application	Description	Catalog No.
IP, Antibody Purification, F(ab) Purification	PureProteome™ Protein A Magnetic Beads	LSKMAGA10
	PureProteome™ Protein G Magnetic Beads	LSKMAGG10
	PureProteome™ Protein A/G Mix Magnetic Beads	LSKMAGAG10
	PureProteome™ Kappa Ig-Binder Magnetic Beads*	LSKMAGKP02
	PureProteome™ Lambda Ig-Binder Magnetic Beads*	LSKMAGLM02
Biotinylated Molecule Purification	PureProteome™ Streptavidin Magnetic Beads	LSKMAGT10
His•Tag® Tagged Protein Purification	PureProteome™ Nickel Magnetic Beads	LSKMAGH10
Custom Labelled (Flexibility to Bind Ligand of Choice)	PureProteome™ NHS FlexiBind Magnetic Beads	LSKMAGN04
	PureProteome™ Carboxy FlexiBind Magnetic Beads**	LSKMAG1CBX10
Magnetic Stands	PureProteome™ Magnetic Stand, 8-well	LSKMAGS08
	PureProteome™ Magnetic Stand, 15 mL	LSKMAGS15

*Human only.

**Available in 0.3, 1.0 and 2.5 µm.

Agarose Based Affinity Purification ▶

Agarose resins are the preferred approach for large purifications and a convenient option when scaling up will be needed. We offer a complete portfolio of agarose resins and kits for antibody purification, immunoprecipitation, and purification of tagged proteins.

Ordering Information

Description	Size	Catalog No.
Protein A Agarose	1.5 mL	IP02-1.5ML
	10 mL	16-125
Protein A Agarose Fast Flow	10 mL	16-156
Protein G Agarose	1.5 mL	IP04-1.5ML
	10 mL	16-266
Protein A + Protein G Agarose	1.5 mL	IP05-1.5ML
	10 mL	IP10-10ML

Affinity Purification with Recombinant Fusion Tags ▶

Recombinant protein purification by tag-specific affinity chromatography is a proven technology that results in highly specific recognition and purification of recombinant proteins. Our broad line of purification and detection tools includes the HIS-Select®, GST, HA, and FLAG® reagents and other technologies.

FLAG® System ▶

The FLAG® Expression System is a tested method for expression, purification, and detection of recombinant fusion proteins. The FLAG® and 3x FLAG®

Antibody Purification and Immunoprecipitation ▶

Protein A and Protein G are proteins of microbial origin that bind specifically to mammalian immunoglobulins. When coupled to agarose, they provide an efficient tool for purification and immunoprecipitation of antibodies. Immunoglobulins of various species interact differently with the two proteins. Agarose that combines Protein A and Protein G provides the binding characteristics of both in a single reagent.

systems are useful in western blotting, immunocytochemistry, immunoprecipitation, flow cytometry, protein purification, and in the study of protein-protein interactions. These small hydrophilic tags significantly improve detection and purification of recombinant fusion proteins when used with our highly specific and sensitive anti-FLAG® antibodies. Sensitivity can be enhanced up to 200-fold using the 3x FLAG® epitope.

- Sequence is highly charged and useful for sensitive detection
- Sensitivity can be enhanced using the 3x FLAG® epitope
- Enhances the study of low-abundance proteins and the optimization of difficult protein expression projects

Ordering Information

Description	Pack Size/Quantity	Catalog No.
Purification		
FLAG® Affinity Gels		
ANTI-FLAG® M1 Agarose Affinity Gel	1 mL, 5 mL, 10 mL, 25 mL	A4596
ANTI-FLAG® M2 Affinity Gel, Purified Immunoglobulin, Buffered Aqueous glycerol solution	1 mL, 5 mL, 10 mL, 25 mL, 2 x 25 mL, 4 x 25 mL	A2220
EZview™ Red ANTI-FLAG® M2 Affinity Gel	500 µL, 1 mL, 5 X 1 mL	F2426
FLAG® Magnetic Beads		
ANTI-FLAG® M2 Magnetic Beads	1 mL, 5 mL	M8823
FLAG® 96-well Format		
FLAG® M Purification Kit, For Mammalian expression systems	1 Kit	CELLMM2
ANTI-FLAG® High Sensitivity, M2 coated 96-well plates, 96-well, clear, polystyrene, flat bottom plate	1 Each, 5 Each, 100 Each	P2983
FLAG® HA Affinity Purification Kits		
FLAG® HA Tandem Affinity Purification Kit	5 Reactions	TP0010
FLAG® Peptides		
FLAG® Peptide, lyophilized powder	4 mg, 25 mg	F3290
3X FLAG® Peptide, lyophilized powder	1 mg, 4 mg, 25 mg	F4799

HIS-Select® System ►

Our HIS-Select® products purify histidine-tagged proteins quickly and with high selectivity made possible by a patented HIS-Select® metal chelate linker which is hydrophilic and non-charged. Because the HIS-select® linkage chemistry is uncharged, non-specific binding of unwanted proteins is dramatically reduced. In addition, the novel tetradentate chelator used in the HIS-Select® products reduces nickel leaching from the affinity gel, affording higher purity and binding capacity for histidine-tagged proteins. The need for secondary purification of HIS-Select® tagged proteins is eliminated due to a single-step purification procedure.

Features and Benefits

- One-step purification
- High selectivity for enhanced purity of target proteins
- Non-charged, hydrophilic linkage reduces non-specific binding
- Pure tetradentate chelate for minimal metal leaching

Ordering Information

Description	Pack Size/Quantity	Catalog No.
HIS-Select® Affinity Gels		
HIS-Select® Nickel Affinity Gel	1 mL, 5 mL, 25 mL, 100 mL, 500 mL	P6611
HIS-Select® HF Nickel Affinity Gel, High Flow	1 mL, 10 mL, 25 mL, 100 mL, 500 mL	H0537
HIS-Select® Cobalt Affinity Gel	5 mL, 25 mL, 100 mL	H8162
IMAC-Select Affinity Gel	5 mL, 25 mL, 100 mL	I1408
EZview™ Red HIS-Select® HC Nickel Affinity Gel	1 mL, 5 X 1 mL	E3528
HIS-Select® Convenient Formats		
HIS-Select® Spin Columns	10 Each, 50 Each	H7787
HIS-Select® 96-well Format		
HIS-Select® Filter Plate	1 Each, 5 X 1 Each	H0413
HIS-Select® Buffers		
HIS-Select® Wash Buffer	500 mL, 1 L	H5288
HIS-Select® Elution Buffer	250 mL, 500 mL	H5413

His•Tag® Purification

Ni-NTA His•Bind® Resin has a binding capacity of over 10 mg of His-Tagged fusion protein per mL resin.

The agarose matrix on the Ni-NTA His•Bind® Superflow™ Resin is structured with more crosslinking for enhanced bead rigidity, for exceptional compatibility with FPLC.

Our IDA His•Bind® resins are offered uncharged to allow flexibility of choice in the metal ion (Nickel, Cobalt, Zinc, Iron, Copper, etc.). IDA supports can be recycled many times with no loss in performance.

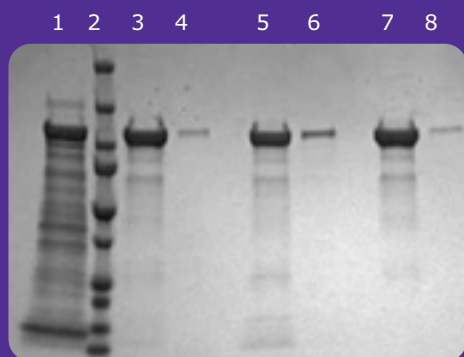

- Target Protein

Lane	Sample
1	Crude Extract
2	Markers
3	Ni-NTA Competitor Q Elution
4	Ni-NTA Competitor Q Strip
5	Ni-NTA Competitor G Elution
6	Ni-NTA Competitor G Strip
7	Ni-NTA His•Bind® Elution
8	Ni-NTA His•Bind® Strip

Ni-NTA His•Bind® performance vs. equivalent competitor resins Vector pET-28b (+) was used to express a His-Tag fusion protein of 119KDa in E. coli BL21 (DE3) cells, induced culture was processed with BugBuster® Master Mix, and protein extract was divided evenly to proceed to the His-Tag purification using Ni-NTA His•Bind®, Ni-NTA Competitor Q and Ni-NTA Competitor G resins. Ni-NTA His•Bind® resins show higher binding capacity and a better purification.

Ordering Information

Application	Description	Catalog No.
Ni-NTA His•Bind® Resin		
Small to medium scale	Ni-NTA His•Bind® Resin	70666
Gravity flow column	BugBuster® Ni-NTA His•Bind® Purification Kit	70751
Recommended for eukaryotic extracts	Ni-NTA Buffer Kit	70899
Ni-NTA His•Bind® Superflow™ Resin		
Small to production scale	Ni-NTA His•Bind® Superflow™ Resin	70691
FPLC or gravity flow column	Ni-NTA Buffer Kit	70899
Uncharged IDA His•Bind® Resin		
Uncharged (metal flexibility)	IDA His•Bind® Resin	69670
Reusability	His•Bind® Buffer Kit	69755
Small to medium scale	His•Bind® Purification Kit	70239
Gravity flow column or batch mode	BugBuster® His•Bind® Purification Kit	70793

GE HisTrap™ Columns

Prepacked HisTrap™ columns from GE Healthcare deliver maximum convenience for greater flexibility and reduced hands-on operation.

- Simple, high resolution purification of histidine-tagged proteins
- Minimized risk of deactivation of target proteins due to broad compatibility with a wide range of reducing agents, detergents, and other additives
- HisTrap™ Fast Flow Column delivers fast flow rate purification and easy scale-up

Ordering Information

Description	Qty	Catalog No.
Prepacked columns and kit		
HisTrap™ High Performance Column	5 × 1 mL	GE17-5247-01
HisTrap™ High Performance Column	1 × 5 mL	GE17-5248-01
HisTrap™ High Performance Column	5 × 5 mL	GE17-5248-02
HisTrap™ High Performance Column	100 × 5 mL	GE17-5248-05
HisTrap™ High Performance Kit	1 Kit	GE17-5249-01
For high flow rate purification, scale-up and manual purification		
HisTrap™ Fast Flow Column	5 × 1 mL	GE17-5319-01
HisTrap™ Fast Flow Column	5 × 5 mL	GE17-5255-01
HisPrep™ Fast Flow 16/10 Column	1 × 20 mL	GE28-9365-51

Hemagglutinin (HA) Purification & Detection ▶

Exceptional sensitivity and specificity for detection of Hemagglutinin (HA) — tagged proteins. The HA peptide is suitable for use in immunoblotting or to elute HA-tagged fusion proteins.

Ordering Information

Description	Pack Size/Qty	Catalog No.
Influenza Hemagglutinin (HA) Peptide, ≥ 97% (HPLC)	.5 mg, 1 mg	I2149
Monoclonal Anti-HA antibody produced in mouse purified immunoglobulin, clone HA-7	200 µL	H3663
Monoclonal Anti-HA–Agarose antibody produced in mouse clone HA-7, purified immunoglobulin	1 mL, 5 × 1 mL	A2095
Anti-HA Immunoprecipitation	1 Kit	IP0010
Monoclonal Anti-HA–Peroxidase antibody produced in mouse, clone HA-7, purified immunoglobulin, lyophilized powder	1 Vial	H6533
EZview™ Red Anti-HA Affinity Gel	500 µL, 1 mL, 5 × 1 mL	E6779

GST•Tag™ Purification

The GST fusion system is based on the widely recognized affinity of glutathione-S-transferase (GST) fusion proteins for immobilized glutathione. Our GST Resin utilizes an 11-atom spacer arm to covalently attach reduced glutathione to the solid support via a sulfide linkage. The resin can be reused several times without loss of capacity, and the high degree of substitution of glutathione ensures exceptional binding capacity.

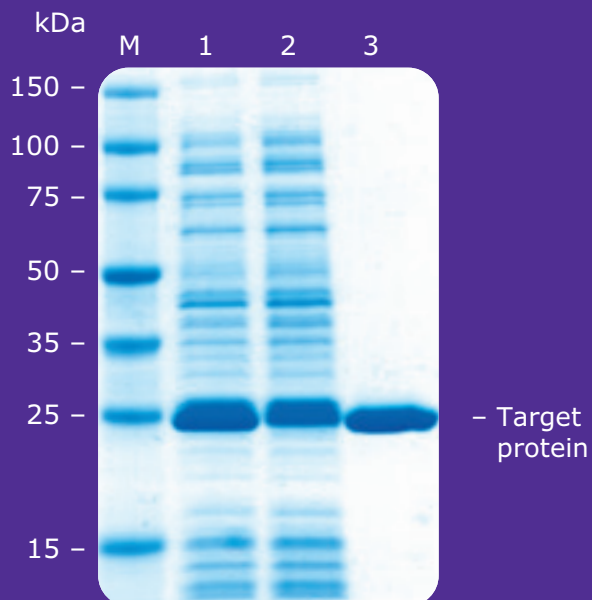

Lane	Sample
M	PerfectProtein™ markers 15–150 kDa
1	BugBuster® extract
2	Flow-through
3	Eluate

GST•TAG™ Purification

GST•Bind™ purification. A crude extract containing unfused GST was applied to a 2 mL GST•Bind™ Resin column. Total protein yield after purification was 8 mg/mL resin.

S•Tag™ Purification

The S•Tag™ fusion protein is a short 15-aa sequence that specifically binds with high affinity the 104-aa S-Protein (KD = 10⁻⁹ M, 1000 times stronger than the interaction between nickel and His•Tag® fusion protein). Fusion proteins can be easily purified by cleavage with site-specific proteases or in acidic buffers.



Lane	Sample
M	PerfectProtein™ markers 15–150 kDa
1	Crude extract
2	Flow-through
3	Wash 1
4	Wash 2
5	Eluate + Biotinylated Thrombin
6	Eluate after Biotinylated Thrombin removal

S•Tag™ affinity purification

S•Tag™ β-gal expressed from a pET construct was purified from a crude soluble fraction using S-protein Agarose under native conditions. Elution of the target protein from the agarose was performed by digestion with Biotinylated Thrombin, which was subsequently removed with Streptavidin Agarose. The fractions are indicated.

Strep•Tag® II Purification

The Strep•Tag® fusion protein II is an 8 amino acid sequence that binds to the biotin pocket of Streptavidin with 100 times higher binding capacity.

T7•Tag® Purification

Purification is antibody-based. Covalently coupled to agarose beads, the T7•Tag® monoclonal antibody captures the T7•Tag® epitope — a sequence of 11 amino acids.

Streptavidin Agarose

Cross-linked agarose is covalently coupled with pure streptavidin under controlled conditions. The stable linkage to the resin minimizes leaching of the streptavidin while maintaining full binding activity. The matrix is suitable for use in column and batch formats for any application that requires high biotin binding capacity and low non-specific binding, and is ideal for affinity purification of biotinylated proteins or pull down experiments of biotinylated DNA/RNA probes. The resin has no detectable protease, DNase, or RNase.

Ordering Information

Description	Catalog No.
GST•Tag™ Purification	
GST•Bind™ Resin	70541
GST•Bind™ Buffer Kit	70534
BugBuster® GST•Bind™ Purification Kit	70794
S-Tag Purification	
S-protein Agarose	69704
S•Tag™ Thrombin Purification Kit	69232
S•Tag™ rEK Purification Kit	69065
Strep•Tag® II Purification	
Strep-Tactin® Superflow Agarose	71592
Strep-Tactin® Buffer Kit	71613
Strep-Tactin® SpinPrep Kit	71608
D-Desthiobiotin	71610
T7•Tag® Purification	
T7•Tag® Affinity Purification Kit	69025
T7•Tag® Antibody Agarose	69026

Description	Size	Catalog No.
Streptavidin Agarose	5 mL	69023-3
	10 mL	16-126

Protein Depletion

Seppro® Protein Depletion Technology

Overcome protein sample complexity — Separate with Seppro® Depletion Technology

Seppro® Depletion Technology enables removal of highly abundant proteins that may mask target protein detection from a variety of biological samples using the affinity of avian polyclonal IgY antibodies.

The Seppro® platform, incorporating Supermix technology, represents the most complete human protein depletion

system available, removing 14 of the most abundant proteins from human serum or plasma, as well as other high and medium abundance proteins. Additional products are available for the depletion of mouse and rat samples, as well as the industry's only depletion system for the removal of Rubisco from plant samples.

Ordering Information

Description	Capacity	Uses	Proteins Depleted	Catalog No.
Human				
IgY14 Spin Columns	15–20 µL	200	14 most abundant proteins	SEP010
IgY14 LC2	40–50 µL	100		SEP020
IgY14 LC5	100 µL	100		SEP030
IgY14 LC10	200–250 µL	100		SEP040
HT IgY14 96 well plate	1.5–2.0 µL per well	10		S2453
Human Supermix LC2	Flow through from IgY14 LC5	100	Moderately abundant proteins, resulting in 99% total protein removal	SEP050
Human Supermix LC5	Flow through from IgY14 LC10	100		SEP060
Rat				
Rat Spin Columns	15–20 µL	200	7 most abundant proteins	SEP130
Rat LC 10	200–250 µL	100		SEP120
Mouse				
Mouse Spin Columns	15–20 µL	200	7 most abundant proteins	SEP110
Mouse LC10	200–250 µL	100		SEP090
Mouse Supermix LC5	Flow-through from mouse LC10	100	Further partitions complex mouse plasma/serum samples	SEP100
Plant				
RuBisCO Spin Columns	15–20 µL	200	RuBisCO (Ribulose-1,5- bisphosphate carboxylase/oxygenase)	SEP070
RuBisCO LC2	40–50 µL	100		SEP080

ProteoExtract® Agarose Columns

Human serum and plasma samples are rich sources of proteomic information, reflecting processes regulating normal or diseased states. Today's ultra-sensitive analytical methods, such as two-dimensional (2D) gel electrophoresis and mass spectrometry, can detect minute changes in expression profiles — but ultrasensitive approaches typically require the removal of highly abundant proteins (HAP) and moderately abundant proteins (MAP).

We offer a range of kits and resins for depleting high-abundance proteins (HAP) from serum or plasma samples. Choose from the PureProteome™ magnetic bead kits and resins or the ProteoExtract® agarose columns. First, identify the species of your serum/plasma source — the following tables summarize the different solutions for your needs.

Ordering Information

Description	Format	Species	Proteins Depleted	Catalog No.
ProteoExtract® Albumin/IgG Depletion Kit	Agarose columns	Human, rabbit, rat, mouse, pig and bovine	Albumin and IgG > 80%	122642
ProteoExtract® Albumin Depletion Kit			Albumin > 80%	122640

Application	Description	Catalog No.
Depletion/Enrichment	PureProteome™ Albumin Magnetic Beads	LSKMAGL10
	PureProteome™ Albumin/IgG Depletion Kit	LSKMAGD12
	PureProteome™ Human Albumin/Immunoglobulin Depletion Kit*	LSKMAGHDKIT

*Human only.

ProteoPrep® Immunoaffinity Albumin & IgG Depletion Kit

The ProteoPrep® Immunoaffinity medium in prepacked spin columns is a mixture of two-beaded media containing recombinantly expressed, small single-chain antibody ligands, providing low non-specific binding and high capacity. This kit is also effective in depleting albumin and IgG from mouse and guinea pig serum.

The ProteoPrep® Blue Albumin & IgG Depletion Kit is designed to specifically remove albumin and IgG from 25 samples of human serum (25 µL to 100 µL) in preparation for two-dimensional electrophoresis (2DE). Albumin-depleted serum samples generated by this kit are in urea rather than salt-based buffers with little dilution, eliminating the need to precipitate the sample prior to performing 2DE.

Ordering Information

Description	Format	Proteins Depleted	Catalog No.
ProteoPrep® Immunoaffinity Albumin & IgG Depletion Kit	Spin Column	Albumin > 95%, IgG > 85%	PROTIA
ProteoPrep® Blue Albumin & IgG Depletion Kit		Albumin > 85%, IgG > 70%	PROTBA

Amicon® Pro Purification System

Purify biologically active proteins with gentle, all-in-one recovery.

Biologically active proteins yield meaningful data. When you start with consistent yields of active, native-folded protein, you're giving your experiment the best chance to succeed. If your current protein preps involve juggling columns, dialyzers and multiple transfer steps, you could be introducing variability into your data. For your next protein preparation, choose the simple, gentle method that tackles even the most labile and poorly expressed proteins — the Amicon® Pro purification system. When your proteins behave, your research will flourish.



WORKING WITH PROTEINS?

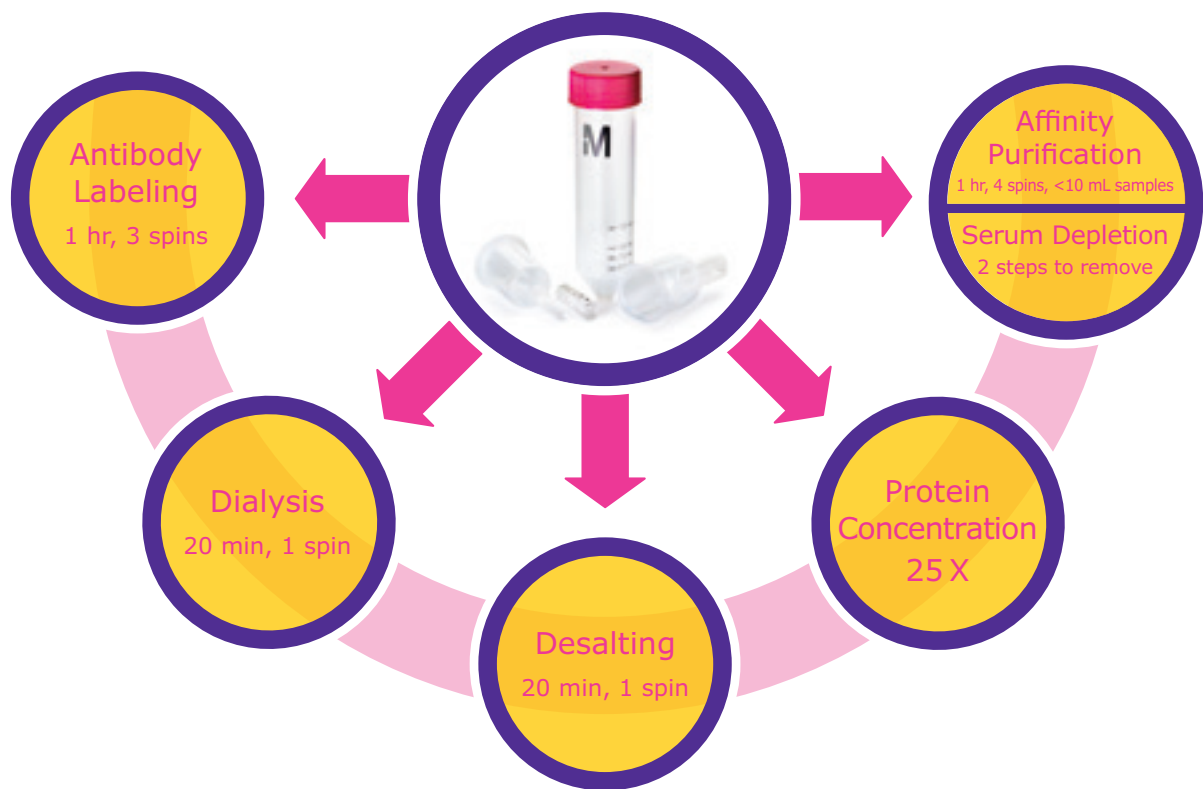

A simple, flexible tool for the basic researcher.

Whether you're performing affinity purification from a precious sample, labeling antibodies, depleting abundant proteins from serum samples or removing salts from a chromatography sample, the Amicon® Pro system is your sample preparation partner. The modular design not only allows flexibility in application, but also offers unprecedented simplicity in protein sample preparation.

Examples:

- Turn your crude lysate into a purified, concentrated protein ready for your downstream assay in as few as four spins.
- Perform a 99% buffer exchange using a patent-pending, continuous, gentle process in one spin.

Don't lose protein in multiple devices.

Maximize your protein recovery with the Amicon® Pro System. ●

Traditional protein purification can be a long process with multiple steps and devices, which can often result in protein degradation and loss along the way. By using the Amicon® Pro Purification System, you can avoid the risks involved with sample transfer while reducing hands-on time.

Whether you need to affinity purify, concentrate, dialyze, or any combination of the three, the Amicon® Pro Purification System will save time and improve your protein recovery. It can help you perform multiple protein preparations in parallel, improving prep-to-prep reproducibility and enabling head-to-head comparison of expression constructs.

Amicon® Pro system unique design features and workflow benefits

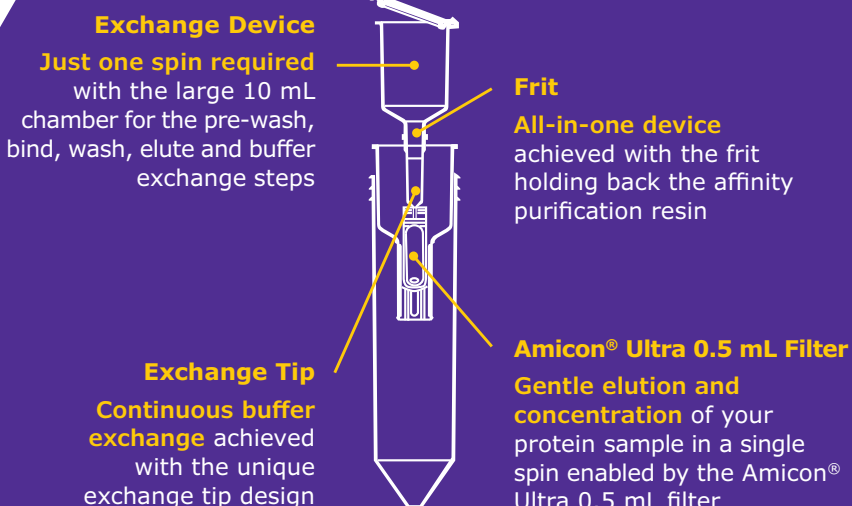

"If I was doing things the old way, I would be six months — if not a year — behind where I am right now with my project."

-Jason Lehmann, Amicon® Pro user, University of California in San Diego

Ordering Information

To choose the appropriate Amicon® Pro device, determine the nominal molecular weight cut-off (NMWCO) for your protein of interest and your desired affinity purification scheme. For convenience and ease of use, the Amicon® Pro purification kits contain devices, reagents and buffers optimized for twelve reactions. These kits are ideal for affinity purification of tagged recombinant proteins, antibody purification and depletion.

Amicon® Pro Purification Kits 12/pk Includes reagent kit (resin and buffers)	Reagent Kit Only	NMWCO				
		3,000	10,000	30,000	50,000	100,000
Amicon® Pro Affinity Concentration Kit Ni-NTA	ACR5000NT	ACK5003NT	ACK5010NT	ACK5030NT	ACK5050NT	ACK5100NT
Amicon® Pro Affinity Concentration Kit Protein A	ACR5000PA	ACK5003PA	ACK5010PA	ACK5030PA	ACK5050PA	ACK5100PA
Amicon® Pro Affinity Concentration Kit Protein G	ACR5000PG	ACK5003PG	ACK5010PG	ACK5030PG	ACK5050PG	ACK5100PG
Amicon® Pro Affinity Concentration Kit GST	ACR5000GS	ACK5003GS	ACK5010GS	ACK5030GS	ACK5050GS	ACK5100GS

Amicon® Pro purification system — No Reagents Included	NMWCO				
	3,000	10,000	30,000	50,000	100,000
Amicon® Pro Purification System Trial Pack 2/pk	ACS500302	ACS501002	ACS503002	ACS505002	ACS510002
Amicon® Pro Purification System 12/pk	ACS500312	ACS501012	ACS503012	ACS505012	ACS510012
Amicon® Pro Purification System 24/pk	ACS500324	ACS501024	ACS503024	ACS505024	ACS510024

Amicon® Pro Purification System 24/pk without Amicon® Ultra 0.5 mL filter: ACS500024

Protein Purification with Protease Cleavage Enzymes

Featured Products

Restriction and Biotinylated Grade Thrombin ●

Highly efficient, specific cleavage of fusion proteins

Restriction Grade Thrombin is qualified to specifically cleave target proteins containing the recognition sequence LeuValProArg↓GlySer. The preparation is functionally tested for activity with fusion proteins and is free of detectable contaminating proteases. Thrombin is supplied with 10X Thrombin Cleavage Buffer and a Cleavage Control Protein.

Biotinylated Thrombin is identical in activity to Restriction Grade Thrombin, but has covalently attached biotin for easy removal of the enzyme from cleavage reactions using immobilized streptavidin. Our Thrombin Cleavage Capture Kit includes not only biotinylated thrombin and immobilized streptavidin, but also all required buffers and filters for complete, convenient recovery of cleaved protein.

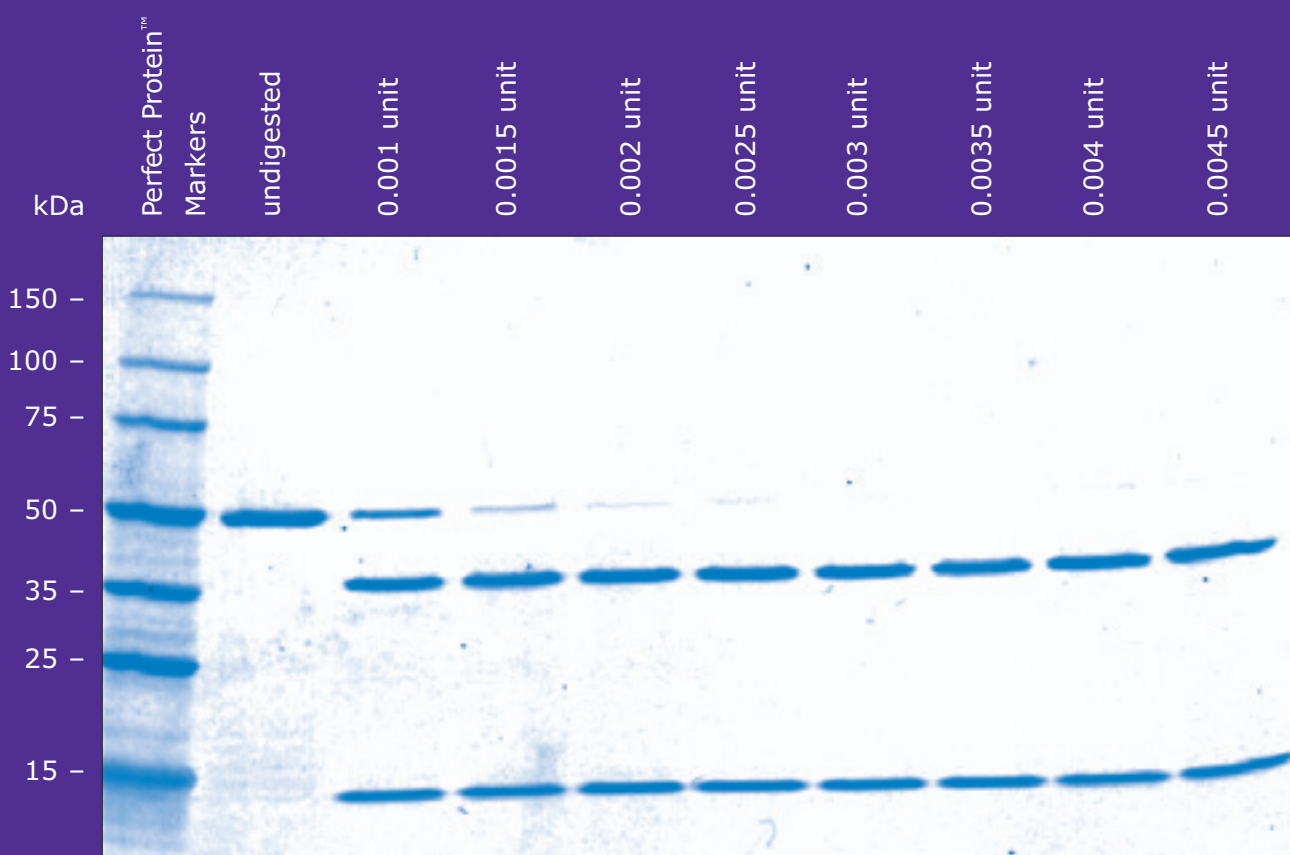

Biotinylated Thrombin cleavage. The indicated amounts of Biotinylated Thrombin were used to cleave 2 μ g of Cleavage Control Protein in an overnight digestion. Samples were analyzed by SDS-PAGE (4–20% gradient gel) followed by staining with Coomassie® blue stain. The 0.0045 unit lane represents a 2.25-fold over-digestion.

HRV 3C Protease

Highly efficient, specific cleavage of fusion proteins

Recombinant type 14 3C protease from human rhinovirus (HRV 3C) is a highly purified, recombinant 6XHis-tagged enzyme, which recognizes the cleavage site LeuGluValLeuPheGln↓GlyPro.

The small, 22 kDa size of the protease, with optimal activity at 4 °C, high specificity, and His-tag fusion make HRV 3C protease an ideal choice for rapid removal of fusion tags.

Lane	Sample
M	PerfectProtein Markers, 10–225 kDa
1	3 µg purified Nus•Tag™ enolase fusion protein
2	3 µg Nus•Tag™ enolase fusion protein with 30 min HRV3C protease reaction
3	3 µg Nus•Tag™ enolase fusion protein with 30 min competitor's protease reaction
4	3 µg Nus•Tag™ enolase fusion protein with 60 min HRV3C protease reaction
5	3 µg Nus•Tag™ enolase fusion protein with 60 min competitor's protease reaction

HRV 3C Protease cleaves fusion proteins more efficiently compared to cleavage with a competitor's protease. Using a 1:100 (w/w) ratio of protease:target protein, 500 µg of purified Nus•Tag™ enolase fusion protein was incubated in parallel 500 µL reactions at 4 °C. The reactions were quenched by adding equal volume 4X SDS Sample Buffer and then immediately placing the samples into a water bath at 75 °C for 5 min.

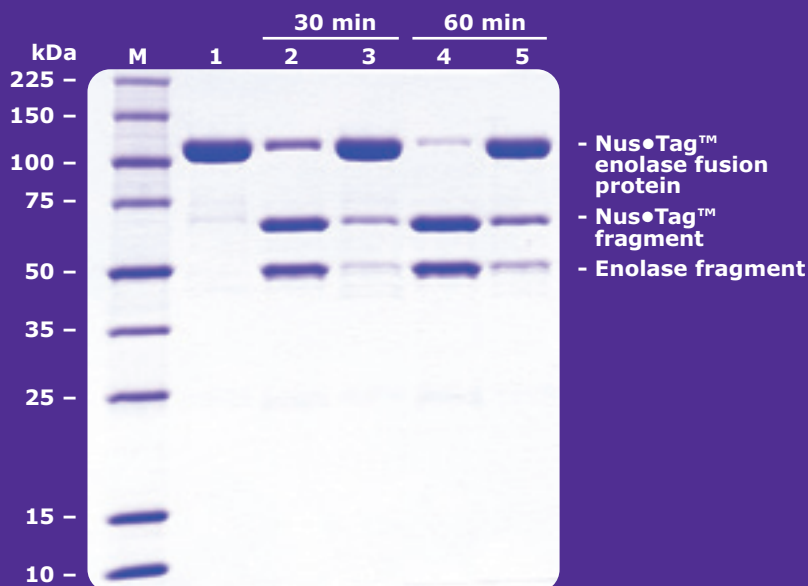

Ordering Information

Description	Catalog No.
Restriction-Grade Thrombin	69671
Biotinylated Thrombin	69672
Thrombin Cleavage Capture Kit	69022
Restriction Grade Factor Xa	69036
Factor Xa Cleavage Capture Kit	69037
Recombinant Enterokinase	69066
Enterokinase Cleavage Capture Kit	69067
HRV 3C Protease	71493
Tag•off™ High Activity rEK	71537
Tag•off™ rEK Cleavage Capture Kit	71540

PROTEIN BUFFER OPTIMIZATION AND SAMPLE CONCENTRATION

When downstream quality matters, make sure your upstream tools are the best. The last steps of preparing a protein sample for downstream analyses, such as activity assays or structural studies, involve ensuring that the protein is in its native, soluble form, dissolved in the buffer of choice, and at an appropriate concentration. With our tools for protein buffer optimization and sample concentration, obtain publication-quality data from every last microgram of protein.

Protein Buffer Exchange, Sample Desalting, and Dialysis ●

Each protein preparation is unique. Give it the special treatment it deserves with a perfectly designed device for dialyzing and buffer exchange. Select between fast and gentle diafiltration using the Amicon® Pro System or dialysis using D-Tube™ Dialyzers.

Sample Needs	Amicon® Pro System	Amicon® Ultra Filter	D-Tube™ Dialyzer
Faster optimization	~20 minutes	< 1 hour	5 hours
Sensitive samples which may precipitate at higher concentrations	+	-	+
Post-dialysis concentration	+	+	-
Limited amounts of exchange solvent	+	+	-
Temperature sensitive	Minimal effect of cold temperature on speed	Minimal effect of cold temperature on speed	Cold temperature reduces speed

Novel engineering provides unmatched buffer exchange. ●

The Amicon® Pro device is the first of its kind to offer dynamic, continuous buffer exchange by diafiltration.

How does it work? The secret is in the design of the Amicon® Pro exchange device and tip. The lower portion of the exchange device is designed to exactly match the contours of the Amicon® Ultra-0.5 mL filter. The tip is tapered to maximize the external-to-internal volume ratio, ensuring that fresh buffer is slowly but consistently metered in, mixed with sample, and forced across the membrane and out. This delivers a continuous, controlled flow during desalting and buffer exchange, without multiple dilute-and-concentrate centrifugation steps. The results are the gentle recovery of greater than 95% of purified protein.

Fast: single spin

Gentle: unique design provides continuous diafiltration

Less Buffer: only 1.5 mL buffer required (given 0.5 mL initial sample)



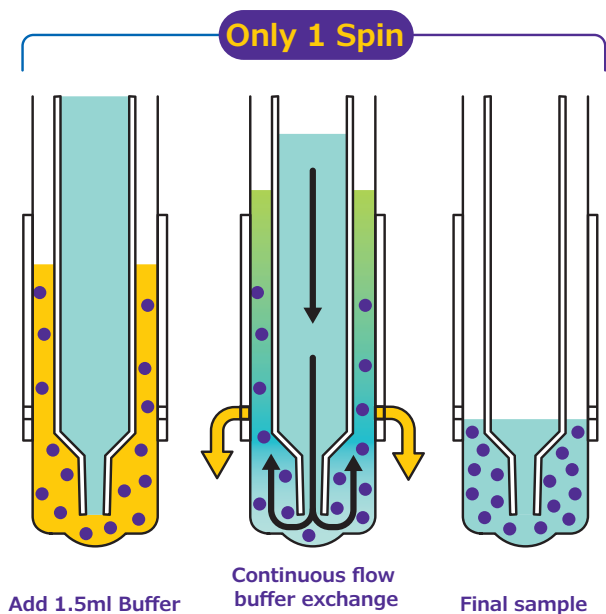

The uniquely designed interface between the exchange tube tip and the Amicon® Ultra device enables greater than 99% buffer exchange in a single spin. Buffer exchange, as shown in this diagram, was measured by the replacement of a low-molecular weight dye (yellow) with clear buffer (black arrows); while a high-molecular weight dye (bright blue) was retained inside the Amicon® Ultra device.

The gentleness of dialysis with the efficiency of diafiltration.

	Dialysis cassette + concentrator	0.5 mL diafiltration device (3 spin)	Amicon® Pro purification system
Process time	16 hours	50 min.	20 min.
Recovery	51 %	> 95%	> 95 %
Specific activity (signal/µg GST-LPP)	0.195	0.17	0.199

Gentler buffer exchange = greater activity. Eluted Samples of GST-lambda protein phosphatase (LPP) buffer exchanged and concentrated using Amicon® Pro device showed greater specific activity and percentage recovery than when prepared with a dialysis cassette (plus concentrator) or 0.5 mL diafiltration spin column.

One hour antibody labeling with the Amicon® Pro system. ●

The unique design of the exchange tip enables single spin diafiltration.

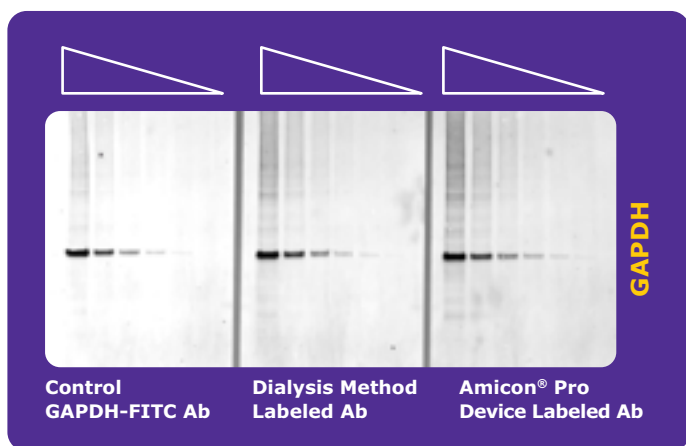

Generate FITC-labeled antibody in one hour. What's faster than labeling antibodies using other purification methods, and more economical than purchasing pre-labeled antibodies? Using Amicon® Pro purification systems for antibody labeling.

Step	Dialysis-based buffer exchange pre/post labeling	Amicon® Pro purification system
Buffer exchange	Overnight	15 min
FITC labeling	3 h	30 min
Free FITC removal and buffer exchange	Overnight	15 min
Total time	3 days	1 h
Antibody recovery	39%	72%

Ordering Information

To choose the appropriate Amicon® Pro device, determine the nominal molecular weight cut-off (NMWCO) for your protein of interest and your desired affinity purification scheme.

Amicon® Pro purification system — No Reagents Included	NMWCO				
	3,000	10,000	30,000	50,000	100,000
Amicon® Pro Purification System 12/pk	ACS500312	ACS501012	ACS503012	ACS505012	ACS510012
Amicon® Pro Purification System 24/pk	ACS500324	ACS501024	ACS503024	ACS505024	ACS510024
Amicon® Pro Purification System 24/pk without Amicon® Ultra 0.5 mL filter	ACS500024				

Featured Products

D-Tube™ Dialyzers

Fast and easy dialysis

Gently dialyze intractable or sensitive samples and prevent them from precipitation or over-concentration. Providing maximum efficiency, D-Tubes™ dialyzers are designed with a double membrane to spread the sample over a large surface area enabling complete dialysis in just two to five hours.



D-Tube™ Dialyzer Advantages:

> 89% Sample Recovery

- Low binding membrane and housing enhance sample recovery

Reliable and Easy to Use

- Secure design prevents sample loss due to leaks — no knots or clamps to loosen and leak
- Easy to open and close with a screw cap
- Rigid frame permits smooth sample withdrawal of submilliliter volumes — removing every last drop is easy

Convenient Sample Loading

- No need to use a syringe to load or remove samples. Simply load your sample with standard pipette tip
- Floating racks fit most standard beakers to hold devices in exchange buffer
- D-Tubes™ dialyzers can also be used to electroelute samples from agarose or acrylamide

Ordering Information

		Product	D-Tube™ Dialyzer Mini	D-Tube™ Dialyzer Midi	D-Tube™ Dialyzer Maxi	D-Tube™ Dialyzer Mega	D-Tube™ Dialyzer Mega
Proteins/DNA/RNA/Oligonucleotides	Molecular Weight Cut-off	Maximum initial sample volume	10 to 250 µL	50 to 800 µL	100 µL to 3 mL	3 to 10 mL	10 to 15 mL
MW	MWCO (Da)	Qty/pk					
MW < 7 k	3,500	10		71506-3	71508-3	71739-3	71742-3
		50				71739-4	71742-4
7 < MW < 24 k	7,000	10	71504-3	71507-3	71509-3	71740-3	71743-3
		50				71740-4	71743-4
		1 plate of 96	71712-3				
24 k < MW	13,000	10	71505-3		71510-3		
		50					
		1 plate of 96	71713-3				
	Floating Rack	Product (Qty/pk)	Mini (10)	Midi (10)	Maxi (10)	Mega (10)	Mega (10)
			71512-3	71513-3	71514-3	71748-3	71748-3

Centrifugal Concentration Devices

Fast and Easy Diafiltration with Amicon® Ultra Centrifugal Filters

Change buffers by gradually adding new solvent during simultaneous ultrafiltration

Because some macromolecules can lose activity or proper structure upon extreme changes of buffer conditions, use diafiltration, which involves removing microsolute by adding solvent to the sample being filtered at the same time that ultrafiltration is being applied.

Advantages of Amicon® Ultra Centrifugal Filters diafiltration:

- Fast — buffer exchange in as few as two spins
- Efficient — requires minimal volume of exchange buffer, easily contained in reservoir
- Easy to use — simply load your sample with standard pipette tip
- Enables simultaneous concentrating and desalting



Featured Products

Amicon® Ultra Centrifugal Filters

Fast and Easy Protein Concentration

Amicon® Ultra Centrifugal filters provide fast sample processing and promote high sample recoveries, even in dilute samples, through ultrafiltration. The unique features of the Amicon® Ultra centrifugal filters give you the fastest, most efficient concentration for sensitive downstream applications.

Amicon® Ultra Centrifugal Filter Advantages:

Maximize Concentration with Highest Protein Recovery – True Engineered Dead Stop

- Avoids spinning to dryness
- Provides a predictable concentration factor
- No need to calibrate for several samples to run in parallel

Reverse Spin Recovery

- Reverse spin devices enable you to maximize protein recovery, especially with small dilute samples, without introducing pipetting errors
- Low binding membrane and polypropylene housing for > 90 % sample recovery



Ultracel® Low-binding Membranes

Fast and Efficient Concentration without Compromise

- Vertical membrane design aligns with filtrate rather than perpendicular for less clogging, less waste, and faster filtration
- Ultra-fast sample processing achieving concentration in as little as 10 minutes
- 25- to 80-fold concentration in a single step

Broad Chemical Compatibility

- Heat-sealed membrane eliminates adhesives and downstream extractables
- Large spectrum of compatibility
- Compatible with pH 1 to 9

Reliable Samples

- Spin precious samples with confidence in one robust, sleek unit that prevents leakage

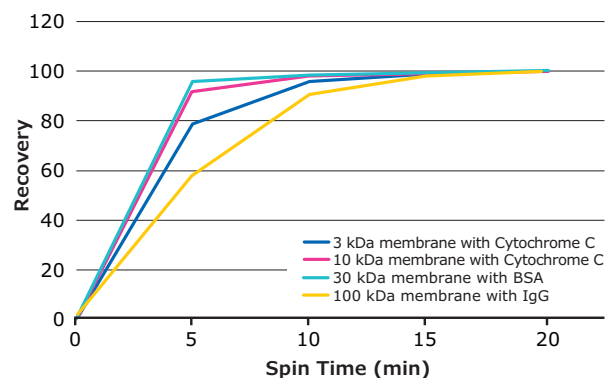

Amicon® Ultra 4 mL Filters – Fast Spin Times with Excellent Recovery

Amicon® Ultra 4 mL filters were tested for percent recovery and spin time.

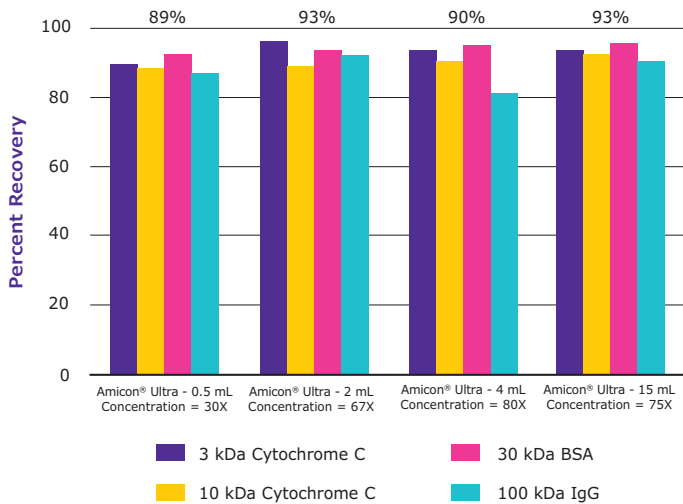

Consistently high recovery of diverse proteins with Amicon® Ultra filters

Concentration and percent recovery using Amicon® Ultra Filters: 4 different devices (Amicon® Ultra-0.5 mL, Amicon® Ultra-2 mL, Amicon® Ultra-4 mL, Amicon® Ultra-15 mL devices) were tested (3 kDa membrane with Cytochrome C, 10 kDa membrane with Cytochrome C, 30 kDa membrane with BSA and 100 kDa membrane with IgG) to determine percent recovery and concentration factor.

To select an Amicon® Ultra Centrifugal Filter, identify the starting volume, molecular weight of protein or nucleic acid being concentrated, final volume and concentration factor.





Then consult the product selection chart below to choose the Amicon® Ultra filter with the right nominal molecular weight cutoff (NMWCO).

	Starting Volume				
	< 0.5 mL	< 2 mL	< 4 mL	< 15 mL	
Molecular Weight (MW)	Proteins				
		NMWCO (Da)			
	6 < MW < 20 k	3,000	3,000	3,000	3,000
	20 < MW < 60 k	10,000	10,000	10,000	10,000
	60 < MW < 100 k	30,000	30,000	30,000	30,000
	100 < MW < 200 k	50,000	50,000	50,000	50,000
200 k < MW	100,000	100,000	100,000	100,000	
Length	Single-Stranded and Double-Stranded Nucleic Acids				
		NMWCO (Da)			
137-1159 bp	30,000	30,000	30,000	30,000	
Particle Diameter (DIA)	Nanoparticles				
		NMWCO (Da)			
	1.5 < dia < 3 nm	3,000	3,000	3,000	3,000
	3 < dia < 5 nm	10,000	10,000	10,000	10,000
	5 < dia < 7 nm	30,000	30,000	30,000	30,000
	7 < dia < 10 nm	50,000	50,000	50,000	50,000
10 nm < dia	100,000	100,000	100,000	100,000	

NMWCO: Nominal Molecular Weight Cut Off

10,000 NMWCO Amicon® Ultra-4 and -15 filters are both marked and registered for *in vitro* diagnostic use.

Once you've chosen the right Amicon® Ultra filter for your needs, choose your rotor, G force and spinning time for concentrating your molecule. Designed as standard 1.5 mL, 15 mL conical or 50 mL conical tubes, Amicon® Ultra filters fit all standard rotor types.

	Amicon® Ultra-0.5 filter	Amicon® Ultra-2 filter	Amicon® Ultra-4 filter	Amicon® Ultra-15 filter	
					
Choose a rotor and G force	Starting Volume	< 0.5 mL	< 2 mL	< 4 mL	< 15 mL
	Final Volume	15–20 µL	15–70 µL	50 µL	200 µL
	Design of the Device	Standard 1.5 mL	Standard 15 mL	Standard 15 mL	Standard 50 mL
	Fixed-Angle (35 °) Rotor	14,000 g 1,000 g reverse spin	7,500 g 1,000 g reverse spin	5,000 g for 100,000 7,500 g for all other MWCO	5,000 g
Swinging Bucket Rotor	N/A	4,000 g 1,000 g reverse spin	4,000 g	4,000 g	
Concentration Factor	Final Volume	15–20 µL with reverse spin	15–70 µL with reverse spin	50 µL	200 µL
	Concentration Factor	X25–X30	X14–X67	X80	X75
Adjust spinning time	For Proteins and Nanoparticles				
	NMWCO (Da)				
	3,000	30 min.	60 min.	40 min.	40 min.
	10,000	15 min.	40 min.	15 min.	20 min.
	30,000	10 min.	20 min.	10 min.	20 min.
	50,000	10 min.	15 min.	10 min.	15 min.
100,000	10 min.	30 min.	10 min.	15 min.	
Single-Stranded and Double-Stranded Nucleic Acids					
30,000	10 min.	15 min., fixed angle 40 min., swinging rotor	10 min., 5,000 g, fixed angle	10 min., 5,000 g, fixed angle	

Amicon® Ultra Centrifugal Filters

	Product	Amicon® Ultra-0.5 filter	Amicon® Ultra-2 filter	Amicon® Ultra-4 filter	Amicon® Ultra-15 filter
	Maximum initial sample volume (mL)	0.5	2	4	15
	Final concentrate (retentate) volume (µL)	15-20	15-70	30-70	150-300
NMWCO (Da)	Qty/Pk				
3,000	8	UFC500308		UFC800308	UFC900308
	24	UFC500324	UFC200324	UFC800324	UFC900324
	96	UFC500396		UFC800396	UFC900396
	500	UFC5003BK			
10,000	8	UFC501008		UFC801008	UFC901008
	24	UFC501024	UFC201024	UFC801024	UFC901024
	96	UFC501096		UFC801096	UFC901096
	500	UFC5010BK			
30,000	8	UFC503008		UFC803008	UFC903008
	24	UFC503024	UFC203024	UFC803024	UFC903024
	96	UFC503096		UFC803096	UFC903096
	500	UFC5030BK			
50,000	8	UFC505008		UFC805008	UFC905008
	24	UFC505024	UFC205024	UFC805024	UFC905024
	96	UFC505096		UFC805096	UFC905096
	500	UFC5050BK			
100,000	8	UFC510008		UFC810008	UFC910008
	24	UFC510024	UFC210024	UFC810024	UFC910024
	96	UFC510096		UFC810096	UFC910096
	500	UFC5100BK			

Amicon® Ultra-4 and -15 Centrifugal Filters, registered for IVD use

Description	NMWCO	Qty/Pk	Catalog No.
Amicon® Ultra-4 Centrifugal Filter	10 KDa	8	UFC801008D
		24	UFC801024D
		96	UFC801096D
Amicon® Ultra-15 Centrifugal Filter	10 KDa	8	UFC901008D
		24	UFC901024D
		96	UFC901096D



Specialized Concentration Devices

Microcon® DNA Fast Flow Filter

Concentration of gDNA and Protein

Optimized for the concentration and recovery of genomic DNA with SDS buffer. The low nonspecific binding characteristics of the membrane and the other device components, coupled with its medical-grade o-ring seal, allow the device to accommodate several wash steps with minimal sample loss.



Microcon® DNA Fast Flow Filter Advantages:

- High recovery for small volumes with reverse spin (concentration factor < 20X)
- Low-binding Ultracel® membrane
- Fast processing

Microcon® Centrifugal Filters

Simply and efficiently concentrate and desalt solutions of any macromolecule with the low-binding Ultracel® membrane, using any centrifuge that can accept 1.5 mL tubes.

Microcon® Filter Advantages:

- Dual-cycle EtO treatment on the Microcon® PCR Grade Filter has been shown to render contaminating DNA unamplifiable
- Typical recoveries of > 95%, even for dilute solutions
- Reverse spin to maximize recovery, even in the smallest samples
- Convenient storage of filtrate or concentrated sample in standard microfuge tube
- Concentration factors up to 100X

Application Guidelines

Application	Microcon® Device		
	10K	30K	DNA Fast Flow
Peptide and growth factor concentration	•		
Protein concentration and desalting of columns eluates	•	•	
Protein concentration before electrophoresis or other assays	•	•	
Protein removal prior to HPLC	•	•	
Purification of macromolecular components found in tissue culture extracts and cell lysates	•	•	
Concentration of biological samples (antigens, antibodies, enzymes)		•	
Concentration of gDNA with or without SDS buffer		•	•
Concentration and desalting of nucleic acids (single- or double-stranded)	•	•	•
Removal of labeled nucleotides	•	•	•
Removal of labeled amino acids	•	•	•
Removal of primers from amplified DNA		•	•
Removal of linkers prior to cloning		•	•

Ordering Information

Description	Volume, mL	Min. final concentrate volume, µL	Qty/Pk	Catalog No.
Microcon® filter, Ultracel®-10 membrane, 10 kDa	0.5	5-50	100	MRCPRT010
Microcon® filter, Ultracel®-30 membrane, 30 kDa	0.5	5-50	100	MRCF0R030
Microcon® DNA Fast Flow Centrifugal Filter with Ultracel® membrane	0.5	5-50	100	MRCF0R100
Microcon® DNA Fast Flow PCR Grade filter with Ultracel® membrane, dual cycle EtO treated	0.5	5-50	20	MRCF0R100ET

Ultrafree® spin filters for clarification, filtration, and sterilization

Ultrafree®-MC and Ultrafree®-CL centrifugal filters remove particles and precipitates from aqueous and some solvent-based samples. These fast filtration units provide highly reproducible performance for sample recovery. Ultrafree® centrifugal filters are ideal for use in protein and nucleic acid solutions.

Ultrafree®-MC filter advantages:

- High recovery Durapore® (PVDF) and hydrophilic PTFE membranes
- Five different pore sizes from 0.1 to 5.0 µm
- Pre-sterilized units also available
- Fast filtration and highly reproducible performance
- Use in fixed-angle rotors for 1.5 mL tubes

Ultrafree®-CL filter advantages:

- High recovery Durapore® (PVDF) and hydrophilic PTFE membranes
- Five different pore sizes from 0.1 to 5.0 µm
- Pre-sterilized units also available
- Fast filtration and highly reproducible performance
- Use in fixed-angle rotors for 15 mL tubes



Sterile Ultrafree®-MC and CL centrifugal filter units with microporous membrane

- Easy, pre-sterilized, centrifugal sample clarification units for either 0.5 mL (MC) or 2 mL (CL) maximum volumes
- High recovery Durapore® (PVDF) membrane
- Fast filtration and highly reproducible performance
- Use in fixed-angle rotors for 1.5 mL tubes (MC) or 15 mL tubes (CL)

Ordering Information

	Pore Size (µm)	Color	Sterility	Qty/Pk	Catalog No.			
Filter Units with Microporous Durapore® PVDF Membrane								
Ultrafree®-MC Filter	0.1	Orange	Non-sterile	25	UFC30VV25			
				100	UFC30VV00			
				25	UFC30GV25			
	0.22	Yellow	Non-sterile	100	UFC30GV00			
				250	UFC30GVNB			
				Sterile	50 (5 x 10)	UFC30GV0S		
				0.45	Red	Non-sterile	25	UFC30HV25
							100	UFC30HV00
							250	UFC30HVNB
	0.65	Purple	Non-sterile	25	UFC30DV25			
				100	UFC30DV00			
				Sterile	50 (5 x 10)	UFC30DV0S		
6	Dark Green	Non-sterile	100	UFC30SV00				
Ultrafree®-CL Filter	0.1	Orange	Non-sterile	25	UFC40VV25			
				100	UFC40VV00			
				25	UFC40GV25			
	0.22	Yellow	Non-sterile	100	UFC40GV00			
				Sterile	50 (5 x 10)	UFC40GV0S		
				0.45	Red	Non-sterile	25	UFC40HV25
							100	UFC40HV00
							0.65	Purple
				5	Dark Green	UFC40SV25	25	UFC40SV25
	Filter Units with Microporous Hydrophilic PTFE Membrane							
	Ultrafree®-MC Filter	0.22	Yellow	Non-sterile	25	UFC30LG25		
		0.45	Red	Non-sterile	25	UFC30LH25		
Ultrafree®-CL Filter	0.22	Yellow	Non-sterile	25	UFC40LG25			
	0.45	Red	Non-sterile	25	UFC40LH25			

Concentrate high solute samples with Centriprep® filters

Centriprep® centrifugal filters are disposable ultrafiltration devices used for purifying, concentrating, and desalting biological samples (2–15 mL volume range) and for filtration applications. Offering a high flow rate, these filters come complete and are easy to use with a twist-lock cap, a filtrate collector containing a low adsorptive Ultracel® regenerated cellulose membrane, plus an air-seal cap for sample isolation.

Centriprep® filter advantages and applications:

- Unique inverse flow mode of operation with large deadstop
- Concentrate and purify particle-laden solutions of high concentrations with Ultracel® membrane
- Fast sample processing
- Fits standard swinging-bucket rotor for 50 mL tubes
- Concentrate and purify particle-laden solutions or high concentrations
- Separate low MW solutes from fermentation broths, cell culture media, cell lysates



Ordering Information

Description	NMWCO (kDa)	Volume (mL)	Min. final concentrate volume (µL)	Qty/Pk	Catalog No.
Centriprep® filter, Ultracel®-3 membrane	3	15	700	24	4302
				96	4303
Centriprep® filter, Ultracel®-10 membrane*	10	15	700	24	4304
				96	4305
Centriprep® filter, Ultracel®-30 membrane*	30	15	700	24	4306
				96	4307
Centriprep® filter, Ultracel®-50 membrane	50	15	700	24	4310
				96	4311

* Centriprep® centrifugal filter devices with Ultracel® 10K and 30K membranes are registered for *in vitro* diagnostic use.

Clinical Ultrafiltration

Separate free from protein-bound solute with Centrifree® filters

The Centrifree® filter was designed with the clinical laboratory in mind. These devices rapidly and efficiently separate free from protein-bound microsolutes in small volumes (0.15–1.0 mL) of serum, plasma, and other biological samples using ultrafiltration. Accurate partitioning occurs in minutes without dilution, change in physiologic pH, ion composition, or unbound microsolite concentration. These devices contain low-adsorptive hydrophilic membranes and O-rings without plasticizers to ensure excellent recovery.

Centrifree® filter advantages and applications:

- Separation of free from bound microsolite in serum, plasma, and other biological samples
- Determine free therapeutic drugs, testosterone, thyroxin, etc.
- Binding studies
- New drug investigations
- Deproteinization



Ordering Information

Description	Volume, mL	Min. final concentrate volume, µL	MWCO (kDa)	Qty/Pk	Catalog No.
Centrifree® Ultrafiltration device with Ultracel® PL membrane	1	50	30	50	4104

Centrifree® filters are registered for *in vitro* diagnostic use.

Minicon® filters to Concentrate Multiple Clinical Samples

Minicon® concentrators are non-sterile, disposable, multiwell ultrafiltration devices designed for concentrating macromolecules in clinical specimens such as urine, cerebrospinal fluid (CSF) or other biological solutions. The concentrators, which require no additional equipment and can be operated unattended, are used by researchers and clinical laboratories worldwide as a preparatory step to increase the sensitivity of subsequent tests.

Minicon® concentrator advantages and applications:

- Concentrate urine and cerebrospinal fluid to intensify proteins that indicate abnormal or pathological states prior to analysis by electrophoresis or immunoelectrophoresis (e.g., Bence Jones proteins in urine)
- Static concentrator, requiring no accessories
- Absorbent pulls solvent and salts through ultrafilter, concentrating sample



Ordering Information

Description	Volume, mL	Min. final concentrate volume, µL	MWCO (kDa)	Qty/Pk	Catalog No.
Minicon® B15 concentrator, 8 cells/unit	5	50	15	40	9031
Minicon® CS15 concentrator, 10 cells/unit	2.5	30	15	50	9051

Minicon® filters are registered for *in vitro* diagnostic use.

Large Volume Concentration

Concentration of proteins and viruses ●

The Centricon® Plus-70 centrifugal filter is designed for rapid processing of aqueous biological solutions in volumes ranging from 15 to 70 mL. Centricon® filters concentrate most 70 mL solutions down to 350 µL in as little as 25 minutes. Samples are typically concentrated in the 50X to 200X range, depending on the sample type and starting sample volume. These units are a convenient alternative to dialysis, lyophilization, or precipitation techniques.

Centricon® Plus-70 filter advantages and applications

- > 90% typical recovery
- Low hold-up volume
- Polypropylene housing minimizes binding
- True dead stop prevents spinning to dryness
- Concentrating and desalting chromatography column eluates
- Concentrating monoclonal antibodies
- Concentrating proteins or viruses from culture supernatants
- Clarifying tissue homogenates and cell lysates



Performance

Spin time with respect to filtrate volume (Ultracel® PL-30 membrane at 3500 xg)

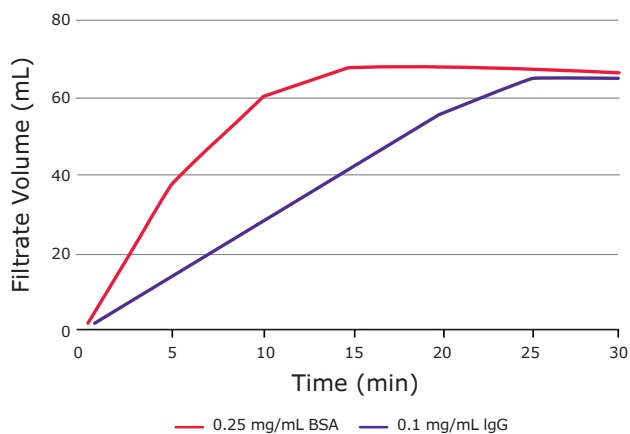

Ordering Information

Description	Volume, mL	Min. final concentrate volume, µL	NMWC0	Qty/Pk	Catalog No.
Centricon® Plus-70 3K filter	70	350	3	8	UFC700308
Centricon® Plus-70 10K filter	70	350	10	8	UFC701008
Centricon® Plus-70 30K filter	70	350	30	8	UFC703008
Centricon® Plus-70 100K filter	70	330	100	8	UFC710008

Amicon® Stirred Cells ●

50 mL to 400 mL concentration

Amicon® stirred cells provide high flow rates with solutions up to 10% macrosolute concentration and are capable of rapid concentration, or salt removal followed by concentration in the same unit. For protein concentration, gas pressure is applied directly to ultrafiltration cell. Solutes above the membrane's nominal molecular weight cut-off (NMWCO) are retained in cell, while water and solutes below the cut-off pass into the filtrate and out of cell.

Advantages

- Gentle magnetic stirring minimizes concentration polarization and shear denaturation.
- All stirred cells can be autoclaved.
- Three different sizes to handle volumes from 50 mL to 400 mL
- High flow rates with solutions up to 10% macrosolute concentration

Applications

- Concentrate, diafilter, and exchange buffers for macromolecule solutions including proteins, enzymes, antibodies and viruses.

Available in three sizes

Max. Working Volume	Catalog No.
50 mL	UFSC05001
200 mL	UFSC20001
400 mL	UFSC40001



Introducing the new Amicon® Stirred Cell.

Order the new 50 mL, 200 mL, or 400 mL stirred cells and you will experience the same performance to which you're accustomed: gentle, high recovery of macrosolutes, thorough buffer exchange, membrane flexibility and ability to monitor filtration progress. In addition, you will enjoy many workflow-enhancing features.

What's new about the updated stirred cells:

- Ergonomic benefits: you will love how easy it is to open, close and assemble the new Amicon® stirred cell!
- Quick connectors to tubing for easy, secure setup.
- Integrated safety features: with screw threads and a pressure relief valve, there's no need for external housing. This means easier assembly and disassembly, and very clear confirmation that the device is properly assembled.
- Overall superior integrity (no leaking).
- Broader selection of membrane discs.
- Fully revised user guide with clearer instructions for operation and how to connect to your gas source.
- Better spare part and accessory support.
- More secure stir bar eliminates risk of damage to your membrane.

Membrane Discs for Use in Stirred Cells

Ultracel® cut disc membranes

To concentrate or desalt dilute solutions, use Ultracel® regenerated cellulose membranes. The hydrophilic, tight microstructure of Ultracel® membranes assures the highest possible retention with the lowest possible adsorption of protein, DNA or other macromolecules.

- Membranes available in 1, 3, 5, 10, 30 and 100 kDa nominal molecular weight limit (NMWL).
- Filter diameters available in 25, 44.5, 47, 63.5, 76, 90 and 150 mm.

For ordering information, visit SigmaAldrich.com/UltracelUFcutdiscs

Biomax® cut disc membranes

To concentrate or desalt higher volumes of more concentrated samples (recommended for protein concentrations greater than 1.0 µg/mL), use Biomax® polyethersulfone (PES) membranes. These membranes are recommended for samples such as serum, plasma, or conditioned tissue culture media.

- Membranes available in 5, 10, 30, 50, 100, 300, and 500 kDa nominal molecular weight limit (NMWL).
- Filter diameters available in 25, 44.5, 47, 63.5, 76, 90 and 150 mm.

For ordering information, please visit SigmaAldrich.com/BiomaxUFcutdiscs

Durapore® cut disc membranes

For large-volume microfiltration, choose Durapore® PVDF membrane discs for your stirred cell.

- Membranes available in 0.1, 0.2 and 0.45 µm pore sizes
- Filter diameters available in 63.5 and 70 mm.

Contact customer service for Durapore® discs ordering information.

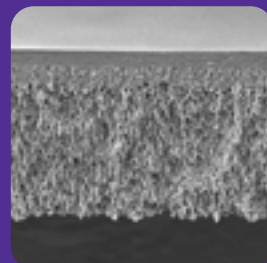

Ultracel® regenerated cellulose ultrafiltration membrane.

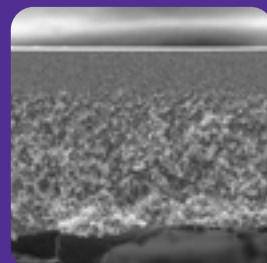

Biomax® polyethersulfone ultrafiltration membrane.

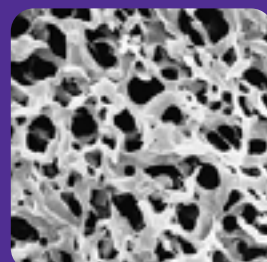

Durapore® polyvinylidene fluoride ultrafiltration membrane.

Stirred Cell Accessories Expand Your Capabilities

Amicon® Stirred Cell Selector Valve (Catalog No. 6003)

Valve with sliding control for instant switching from concentration to diafiltration, or switching gas and liquid lines simultaneously. Simplifies operation and avoids the need for multiple T-fittings and valves.

Amicon® Stirred Cell Manifold (Catalog No. 6015)

For instant direction of gas pressure or liquid flow in multi-cell or multi-reservoir systems. Can pressurize up to 3 cells or reservoirs from one gas source or feed several cells from one reservoir.

Amicon® Stirred Cell Reservoir (Catalog No. 6028)

This 800 mL auxiliary reservoir increases the volume capacity of stirred cells. When pressurized from an external gas source, it automatically replenishes liquid in the cell's built-in reservoir during filtration. The reservoir may also be used to store dialysate during diafiltration or dialysis.

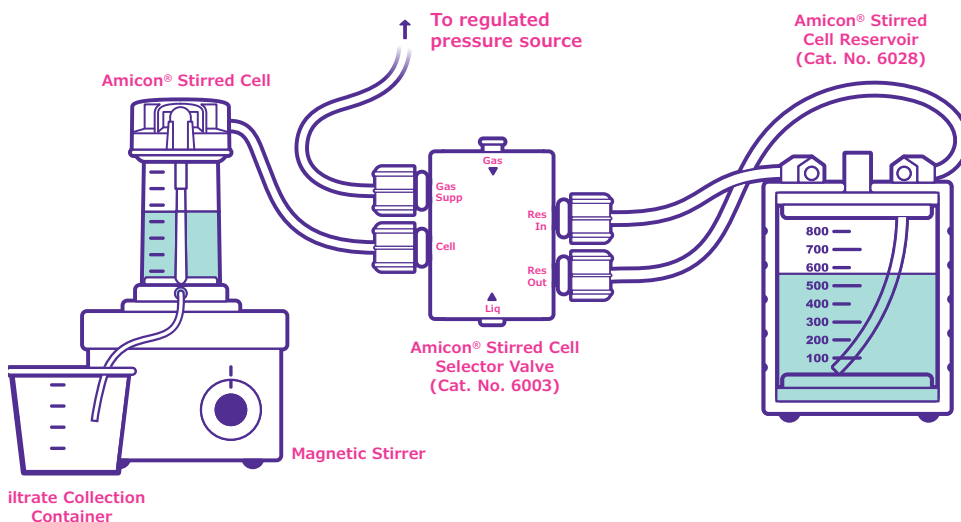

Amicon® Stirred Cell setup for large volume concentration and continuous diafiltration using selector valve and reservoir accessories.

To place an order or receive technical assistance

Order/Customer Service: SigmaAldrich.com/order

Technical Service: SigmaAldrich.com/techservice

Safety-related Information: SigmaAldrich.com/safetycenter

SigmaAldrich.com

